

# JVC



## DVD DIGITAL CINEMA SYSTEM

# TH-A75

Consists of XV-THA75, SP-WA75, SP-XSA75, and SP-XCA75

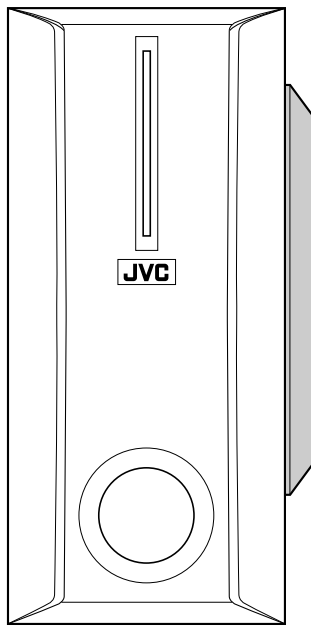

SP-WA75

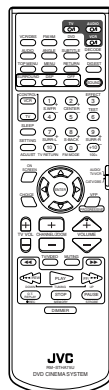

SP-XSA75

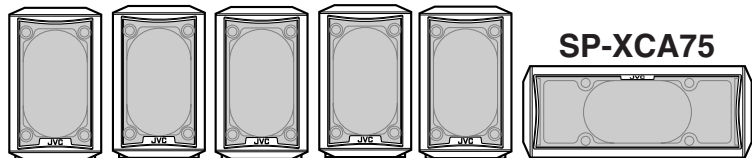

SP-XCA75

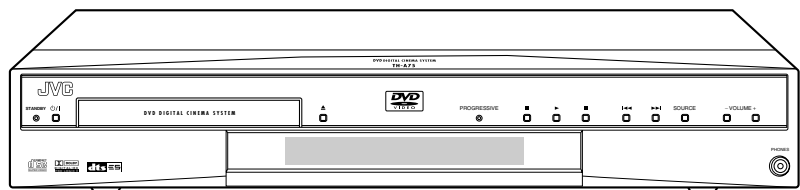

XV-THA75



## INSTRUCTIONS

### For Customer Use:

Enter below the Model No. and Serial No. which are located either on the rear, bottom or side of the cabinet. Retain this information for future reference.

Model No. \_\_\_\_\_

Serial No. \_\_\_\_\_

LVT0958-010A

[A]

# Warnings, Cautions and Others

## Caution — ⏻/I button!

Disconnect the mains plug to shut the power off completely.  
The ⏻/I button in any position does not disconnect the mains line.  
The power can be remote controlled.

## CAUTION

To reduce the risk of electrical shocks, fire, etc.:

1. Do not remove screws, covers or cabinet.
2. Do not expose this appliance to rain or moisture.

## CAUTION

- Do not block the ventilation openings or holes.  
(If the ventilation openings or holes are blocked by a newspaper or cloth, etc., the heat may not be able to get out.)
- Do not place any naked flame sources, such as lighted candles, on the apparatus.
- When discarding batteries, environmental problems must be considered and local rules or laws governing the disposal of these batteries must be followed strictly.
- Do not expose this apparatus to rain, moisture, dripping or splashing and that no objects filled with liquids, such as vases, shall be placed on the apparatus.

## Caution: Proper Ventilation

To avoid risk of electric shock and fire and to protect from damage, locate the apparatus as follows:

- Front: No obstructions open spacing.  
Sides: No obstructions in 10 cm from the sides.  
Top: No obstructions in 15 cm from the top.  
Back: No obstructions in 20 cm from the back.  
Bottom: No obstructions, place on the level surface.

In addition, maintain the best possible air circulation as illustrated.

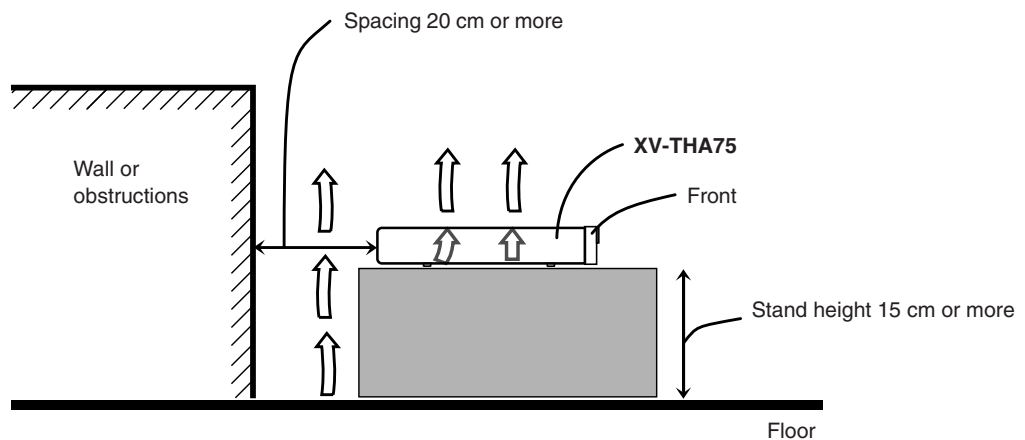

## IMPORTANT FOR LASER PRODUCTS

---

### REPRODUCTION OF LABELS

① CLASSIFICATION LABEL, PLACED ON EXTERIOR SURFACE

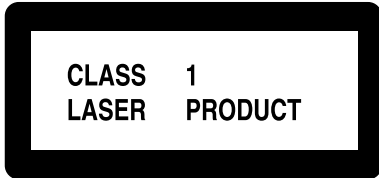

② WARNING LABEL, PLACED INSIDE THE UNIT

<b>CAUTION</b> : Visible and invisible laser radiation when open and interlock failed or defeated. AVOID DIRECT EXPOSURE TO BEAM.	<b>ADVARSEL</b> : Synlig og usynlig laserstråling når maskinen er åben eller interlocken fejler. Undgå direkte eksponering til stråling.	<b>VARNING</b> : Synlig och osynlig laserstråling när den öppnas och spärren är urkopplad. Betrakta ej strålen.	<b>VARO</b> : Avattaessa ja suojalukitus ohitettuna tai viallisena olet alttiina näkyvälle ja näkymättömälle lasersäteilylle. Vältä säteen kohdistumista suoraan itseesi.
---	--	---	---

- 
1. CLASS 1 LASER PRODUCT
  2. **CAUTION:** Visible and invisible laser radiation when open and interlock failed or defeated. Avoid direct exposure to beam.
  3. **CAUTION:** Do not open the top cover. There are no user serviceable parts inside the unit; leave all servicing to qualified service personnel.



# Table of contents

<b>Introduction .....</b>	<b>2</b>	<b>DVD player operations .....</b>	<b>33</b>
About this manual .....	2	<b>Using the on-screen bar .....</b>	<b>33</b>
Precautions .....	2	Showing the on-screen bar .....	33
Checking the supplied accessories .....	2	Basic operation through the on-screen bar .....	34
<b>Names of parts and controls .....</b>	<b>3</b>	<b>Changing the time information .....</b>	<b>34</b>
Center unit .....	3	<b>Locating a particular scene from the disc menu .....</b>	<b>35</b>
Remote control .....	4	Locating a particular scene from the DVD menu .....	35
<b>About discs .....</b>	<b>5</b>	Locating a particular scene from the VCD/SVCD menu with PBC .....	35
Playable disc types .....	5	<b>Selecting a view angle .....</b>	<b>36</b>
Disc structure .....	6	Selecting a view angle .....	36
Playback Control function (PBC)		Showing all view angles on the TV .....	36
—Only for VCD and SVCD .....	6	<b>Changing the subtitle and audio languages .....</b>	<b>37</b>
<b>Getting started .....</b>	<b>7</b>	Selecting the subtitle language .....	37
<b>Connections .....</b>	<b>7</b>	Selecting the audio language .....	37
Connecting a TV .....	7	Selecting the audio channel .....	38
Connecting the AM and FM antennas .....	8	<b>Playing from a particular position .....</b>	<b>39</b>
Connecting the satellite speakers and subwoofer .....	10	Locating a particular chapter—Chapter search .....	39
Installing the satellite speakers on the wall .....	12	Locating a particular position—Time search .....	39
Connecting video components .....	13	Locating a particular scene—DIGEST .....	40
Connecting the power cord .....	14	<b>Special picture playback .....</b>	<b>41</b>
<b>Using the remote control .....</b>	<b>15</b>	Frame-by-frame playback .....	41
Putting batteries in the remote control .....	15	Showing continuous still pictures .....	41
Operating the system using the remote control .....	15	Playing back in slow-motion .....	42
<b>Basic operations .....</b>	<b>16</b>	Zooming in and out .....	42
Turning on the system .....	16	Changing the VFP setting .....	43
Selecting the source to play .....	16	<b>Playing back in the desired order—Program play .....</b>	<b>44</b>
Adjusting the volume .....	17	<b>Playing back in random order—Random play .....</b>	<b>44</b>
Adjusting the output level of subwoofer .....	17	<b>Repeat play .....</b>	<b>45</b>
Turning off the sound temporarily .....	17	Repeating title, chapter, or tracks .....	45
Adjusting the brightness .....	17	Repeating a particular portion—A-B repeat .....	45
Turning off the power with the sleep timer .....	18	<b>MP3 disc playback .....</b>	<b>46</b>
Changing the analog/digital input mode and decoding mode .....	18	Basic operation .....	46
Storing basic adjustments—auto memory .....	19	Operating through the MP3 CONTROL screen .....	47
Changing the scannig mode .....	19	<b>JPEG disc playback .....</b>	<b>48</b>
<b>Basic DVD player operations .....</b>	<b>20</b>	Slide-show .....	48
<b>Tuner operations .....</b>	<b>22</b>	Operating through the JPEG CONTROL screen .....	49
Setting the AM tuner interval spacing .....	22	<b>Using the choice menus .....</b>	<b>50</b>
Tuning in to stations manually .....	22	Choice menus .....	50
Using preset tuning .....	22	Configuration of the choice menus .....	50
Selecting the FM reception mode .....	23	Operation buttons for the choice menus .....	50
Reducing the noise of AM broadcast .....	23	Basic operating procedure .....	51
<b>Basic settings .....</b>	<b>24</b>	<b>LANGUAGE menu .....</b>	<b>52</b>
Operating procedure .....	24	<b>PICTURE menu .....</b>	<b>53</b>
Setting speaker sizes .....	24	<b>AUDIO menu .....</b>	<b>54</b>
Selecting the channel number to reproduce multi-channel digital software .....	24	<b>SPK. SETTING menu .....</b>	<b>55</b>
Setting the speaker distance .....	25	<b>OTHERS menu .....</b>	<b>56</b>
Setting the crossover frequency .....	25	<b>Restricting playback—Parental Lock .....</b>	<b>57</b>
Setting the phase of subwoofer .....	25	Setting Parental Lock .....	57
Setting the video output for DVD playback .....	25	Changing the setting of Parental Lock .....	58
<b>Audio adjustments .....</b>	<b>26</b>	Releasing Parental Lock temporarily .....	58
Operating procedure .....	26	<b>AV COMPU LINK remote control system ...</b>	<b>60</b>
Adjusting the tone .....	26	<b>Operating other manufacturers' video equipment .....</b>	<b>62</b>
Setting the level of the low frequency effect attenuator ...	26	Operating TV .....	62
Setting the dynamic range .....	26	Operating CATV converter or DBS tuner .....	63
Reinforcing the bass sound .....	26	Operating VCR .....	64
Setting the subwoofer audio position .....	26	<b>Maintenance .....</b>	<b>65</b>
Adjusting the front speakers balance .....	26	<b>Troubleshooting .....</b>	<b>66</b>
<b>Creating realistic sound fields .....</b>	<b>27</b>	<b>Glossary .....</b>	<b>69</b>
Surround modes .....	27	<b>Specifications .....</b>	<b>70</b>
DSP modes .....	29		
Using Surround mode .....	31		
Using DSP Mode .....	31		
Adjusting sound .....	32		

# Introduction

## About this manual

This manual mainly explains operations using the buttons and controls on the remote control. You can also use the buttons on the center unit if they have the same or similar names (or marks) as those on the remote control.

If operation using the remote control is different from that using the center unit, then it is explained.

- Times given for various operations are for reference only. Actual time will vary somewhat.
- The following marks are used in this manual:



:Special warnings and cautions you need to know to obtain the best possible performance from the system.



:Specific information and hints you need to know about the features and procedures.



:Available disc types for the operations explained in each section. Unavailable disc types are shown in halftone color.

## Precautions

### Installation of the system

- Select a place which is level, dry and neither too hot nor too cold—between 5°C and 35°C.
- Leave sufficient distance between the system and the TV.
- Do not use the system in a place subject to vibration.

### Power cord

- Do not handle the power cord with wet hands.
- A small amount of power (2.5 watts) is always consumed while the power cord is connected to the wall outlet.
- When unplugging the power cord from the wall outlet, always pull the plug, not the power cord.

### To prevent malfunction of the system

- There are no user-serviceable parts inside. If anything goes wrong, unplug the power cord and consult your dealer.
- Do not insert any metallic object into the system.
- Do not use any of the nonstandard shaped discs (like a heart, flower, or credit card, etc.) available on the market.
- Do not use a disc with tape, stickers, or paste on it.

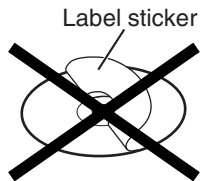
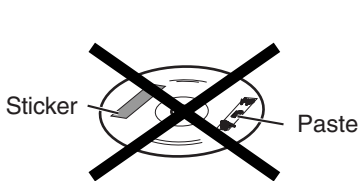

### About copyright laws

Check the copyright laws in your country before recording from DVD Video (DVD), Super Video CD (SVCD), Video CD (VCD), and Audio CD discs. Recording of copyrighted material may infringe copyright laws.

### About the copyguard system

The DVD Video discs are copy-protected. If you connect a VCR between this system and your TV, the copyguard system is activated and the picture may not be played back correctly.

## ■ Safety precautions

### Avoid moisture, water and dust

Do not place the system in moist or dusty places.

### Avoid high temperatures

Do not expose the system to direct sunlight and do not place it near a heating device.

### When you are away

When away on a journey or otherwise, for an extended period of time, remove the plug from the wall outlet.

### Do not block the vents

Blocking the vents may damage the system.

### Care of the cabinet

When cleaning the system, use a soft cloth and follow the relevant instructions on the use of chemically-coated cloths. Do not use benzine, thinner or other organic solvents including disinfectants. These may cause deformation or discoloring.

### If water gets inside the system

Turn the system off and remove the plug from the wall outlet, then call the store where you made your purchase. Continuing use of the system in this state may cause a fire or electrical shock.

## Checking the supplied accessories

Check to be sure you have all the supplied accessories. The number in parentheses is the quantity of the pieces supplied.

If anything is missing, contact your dealer immediately.

### Center unit package

- Remote control—RM-STHA75U (1)
- Batteries—R6S (SUM-3)/AA (15F) (2)
- FM antenna (1)
- AM loop antenna (1)
- Composite video cord (1)
- AV COMPU LINK cord (1)
- Core filter (1)

### Speaker package

- Speaker cords
  - Approx. 5 m (3) with a mini plug
    - :For the left front speaker, right front speaker, and center speaker
  - Approx. 5 m (1) :For the subwoofer
  - Approx. 10 m (3) with a mini plug
    - :For the left surround speaker, right surround speaker, and surround back speaker
- Satellite speakers wall brackets (5)
- Screws for the satellite speakers wall brackets (5)

# Names of parts and controls

See pages in the parentheses for details.

## Center unit

### Front panel

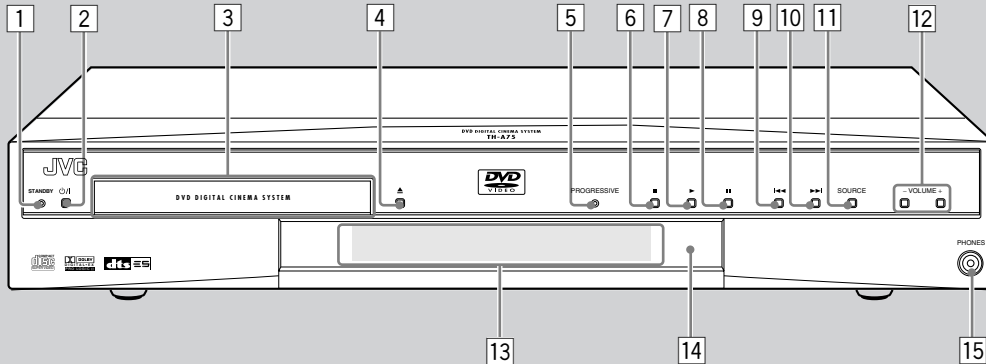

- |                                |  |                            |
|--------------------------------|--|----------------------------|
| 1 STANDBY lamp (16)            | 6 ■ (stop) button (20, 22, 46, 48, 49)       | 11 SOURCE button (16)      |
| 2 ⏻/⏻ (standby/on) button (16) | 7 ► (play) button (20, 46, 48, 49)           | 12 VOLUME +/- buttons (17) |
| 3 Disc tray (20)               | 8    (pause) button (20, 22, 41, 46, 48)     | 13 Display (see below)     |
| 4 ▲ (open/close) button (20)   | 9 ◀◀ (reverse skip) button (20, 46, 48)      | 14 Remote sensor (15)      |
| 5 PROGRESSIVE lamp (19)        | 10 ▶▶ (forward skip) button (20, 22, 46, 48) | 15 PHONES jack (17)        |

### Display

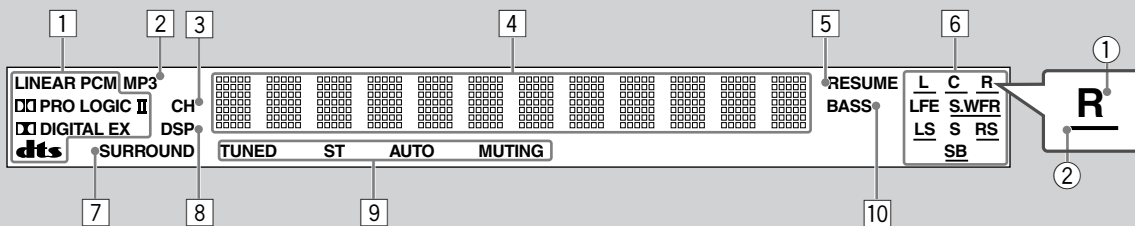

- |   |  |
|---|--|
| 1 • LINEAR PCM indicator (18)                   | 5 RESUME indicator (21, 56)                  |
| • Pro Logic indicators (28)                     | 6 Signal (1) and speaker (2) indicators (30) |
| □ PRO LOGIC, □ PRO LOGIC II                     | 7 SURROUND indicator (27, 28, 30, 31)        |
| • Digital signal format indicators (18, 27, 28) | 8 DSP indicator (29, 31)                     |
| □ DIGITAL, □ DIGITAL EX, DTS                    | 9 Tuner operation indicators (22, 23)        |
| 2 MP3 indicator (46)                            | TUNED, ST (stereo), AUTO MUTING              |
| 3 CH (channel) indicator (23)                   | 10 BASS indicator (26)                       |
| 4 Main display                                  |  |

### Rear panel

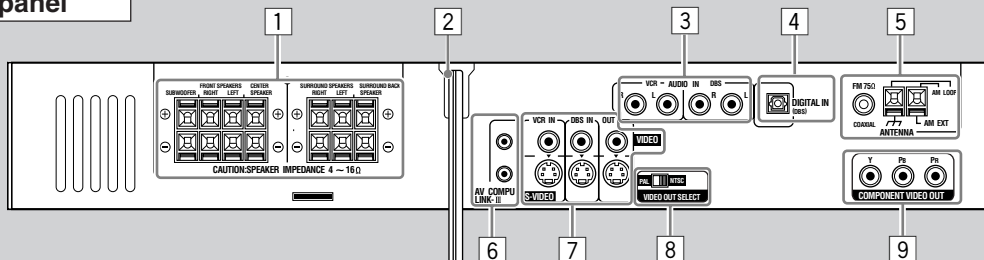

- |   |                                   |  |
|---|-----------------------------------|--|
| 1 Speaker terminals (11)<br>SUBWOOFER,<br>RIGHT/LEFT FRONT SPEAKERS,<br>CENTER SPEAKER,<br>RIGHT/LEFT SURROUND SPEAKERS,<br>SURROUND BACK SPEAKER | 2 Power cord (14)                 | 6 AV COMPU LINK-III jacks (60)                     |
|   | 3 AUDIO IN jacks (13)<br>VCR, DBS | 7 VIDEO jacks<br>VCR IN (13), DBS IN (13), OUT (7) |
|   | 4 DIGITAL IN (DBS) terminal (13)  | 8 VIDEO OUT SELECT switch (7)                      |
|   | 5 ANTENNA terminals (8, 9)        | 9 COMPONENT VIDEO OUT jacks<br>Y, Pb, Pr (7)       |

# Names of parts and controls

## Remote control

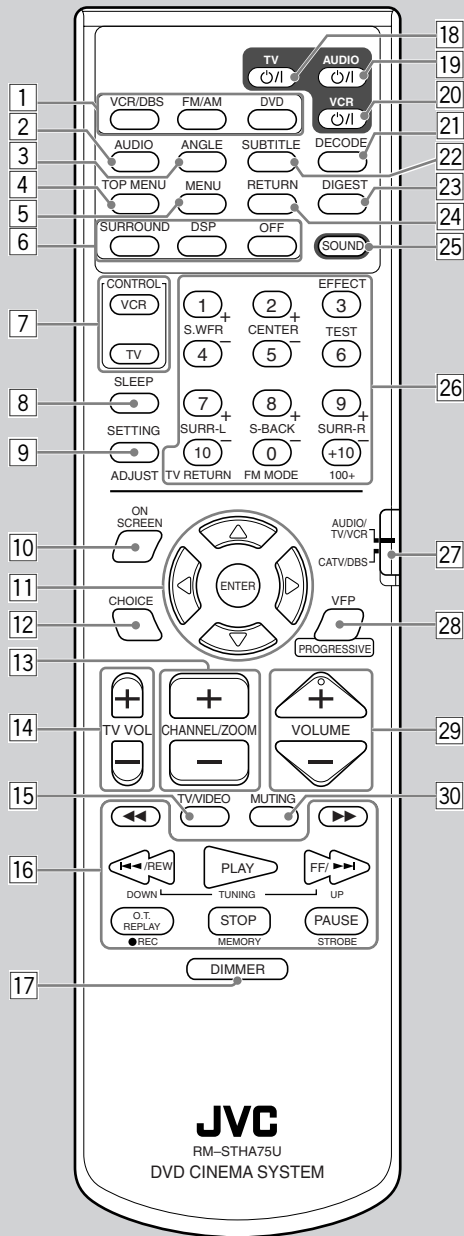

- 1 Source selecting buttons (16)  
VCR/DBS, FM/AM, DVD
- 2 AUDIO button (37, 38)
- 3 ANGLE button (36)
- 4 TOP MENU button (35)
- 5 MENU button (35, 49)
- 6 Surround and DSP operation buttons  
SURROUND (20, 31), DSP (20, 31), OFF (31)
- 7 CONTROL buttons  
VCR (64), TV (62, 63)
- 8 SLEEP button (18)
- 9
  - SETTING button (24)
  - ADJUST button (26)
- 10 ON SCREEN button (33, 34)
- 11
  - ENTER button (34, 47, 49)
  - Cursor  $\blacktriangleright$ / $\blacktriangleleft$ / $\blacktriangledown$ / $\blacktriangleup$  buttons (24, 26, 34, 46 – 49)
  - Choice menu operation buttons (50, 57, 58)
- 12 CHOICE button (50, 57, 58)
- 13
  - CHANNEL +/- buttons (62 – 64)
  - ZOOM +/- buttons (42, 49)
- 14 TV VOL (volume) +/- buttons (62)
- 15 TV/VIDEO button (62)
- 16
  - Disc Operation buttons  
(20, 35, 40 – 42, 46, 48, 49, 64)  
 $\blacktriangleleft$ ,  $\blacktriangleright$ ,  $\blacktriangleleft$ /REW, PLAY, FF/ $\blacktriangleright$ ,  
O.T. (one touch) REPLAY, STOP, PAUSE
  - TUNING UP/DOWN buttons (22)
  - REC button (64)
  - MEMORY button (23)
  - STROBE button (41)
- 17 DIMMER button (17)
- 18 TV  $\odot$ /I button (62, 63)
- 19 AUDIO  $\odot$ /I button (16)
- 20 VCR  $\odot$ /I button (64)
- 21 DECODE button (18)
- 22 SUBTITLE button (37)
- 23 DIGEST button (40)
- 24 RETURN button (35)
- 25 SOUND button (17, 32)
- 26
  - Number buttons  
(21, 23, 35, 39, 44, 47, 49, 57, 58, 62 – 64)
  - Sound setting buttons (17, 32)  
S.WFR +/-, CENTER +/-, SURR-L +/-,  
S-BACK +/-, SURR-R +/-
  - EFFECT button (32)
  - TEST button (32)
  - TV RETURN button (62)
  - FM MODE button (23)
- 27 Remote control mode selector (16, 63)
- 28
  - VFP button (43)
  - PROGRESSIVE button (19)
- 29 VOLUME +/- buttons (17)
- 30 MUTING button (17)



# About discs





## Playable disc types

This system has been designed to play back the following types of discs:

### DVD Video (DVD), Video CD (VCD), Super Video CD (SVCD), Audio CD, CD-R, and CD-RW

- This system can also play back MP3 and JPEG files recorded on CD-Rs and CD-RWs. For in-depth information about MP3, see “MP3 disc playback” on page 46, and for JPEG, see “JPEG disc playback” on page 48.
- Finalized DVD-R discs recorded with the DVD VIDEO format can be played back. However, some discs may not be played back because of the disc characteristics or recording conditions.

### Discs you can play:

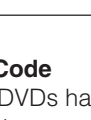
Disc Type	Mark (Logo)	Video Format	Region Code Number*
DVD Video (DVD)		NTSC/PAL	4 ALL
Video CD (VCD)		NTSC/PAL	—
Super Video CD (SVCD)		NTSC/PAL	—
Audio CD		—	—
CD-R		—	—
CD-RW		—	—

#### \* Note on Region Code

DVD players and DVDs have their own Region Code numbers. This system can play back only DVDs recorded with the color system of NTSC or PAL whose Region Code numbers include “4.”

Ex.:



If a DVD with the improper Region Code numbers is loaded, “REGION CODE ERROR” appears on the display and playback cannot start.

- The following disc types cannot be played back: DVD Audio, DVD-ROM, DVD-RAM, DVD-RW, DVD+RW, CD-ROM, CD-I (CD-I Ready), Photo CD, etc. Playing back these discs will generate noise and damage the speakers.

- On some DVD, VCD, or SVCD discs, the actual operations may be different from what is explained in this manual. This is due to the disc programming and disc structure, and this is not a malfunction of this system.

#### Notes on CD-R and CD-RW

- User-edited CD-Rs (Recordable) and CD-RWs (Rewritable) can be played back only if they are already “finalized.”
- The system can play back CD-Rs or CD-RWs recorded on a personal computer if they have been recorded in the Audio CD format. The system can also play back CD-Rs or CD-RWs if MP3 tracks (files) or JPEG files are recorded on them. Note that the configuration and characteristics of an MP3 disc or a JPEG disc is determined by the writing (encoding) software and hardware used for recording. Therefore, due to the software and hardware used, the following symptoms may occur:
  - Some discs may not be played back at all.
  - Some tracks (files) on an MP3 disc are skipped and may not be played back normally.
  - Some files on a JPEG disc may be distorted during playback.
- Before playing back CD-Rs or CD-RWs, read their instructions or cautions carefully.
- CD-RWs may require a longer read-out time. This is caused by the fact that the reflectance of CD-RWs is lower than for regular CDs.

#### ■ About MP3 discs

This system can play MP3 files recorded on a CD-R or CD-RW. We call such a disc “MP3 disc” in this manual. MP3 is an abbreviation of Motion Picture Experts Group 1 (or MPEG-1) Audio Layer 3. MP3 is simply a file format with a data compression. By using MP3 format, one CD-R or CD-RW can contain 10 times as much data volume as a regular CD can.

This system simplifies the hierarchical construction of a disc and calls files and folders as “tracks” and “groups.”

#### ■ About JPEG discs

This system can play JPEG files such as digital photographs recorded on a CD-R or CD-RW. We call such a disc “JPEG disc” in this manual.

JPEG is a still-picture data compression system proposed by Joint Photographic Expert Group, which features small decrease in image quality in spite of its high compression ratio.

This system simplifies the hierarchical construction of a disc and calls folders as “groups.”

# About discs

## Disc structure

A DVD disc consists of “titles,” and each title may be divided into some “chapters.”

For example, if a DVD disc contains some movies, each movie may have its own title number, and it may be further divided into chapters.

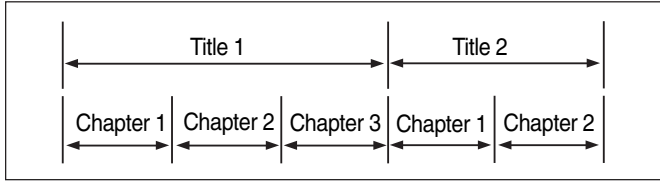

A VCD, SVCD, and Audio CD consist of “tracks.” In general, each track has its own track number. (On some discs, each track may also be divided with Indexes.)

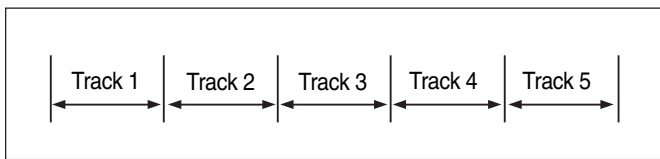

On an MP3 disc, each song is recorded as a track (file). Tracks are usually grouped into a group (folder). Groups can also include other groups, creating hierarchical group layers. This system can recognize up to 150 tracks per group, and up to 99 groups per disc (up to 14,850 tracks).

- If there is any type of files other than MP3 files in a folder, those files are also counted in the total number of 150.

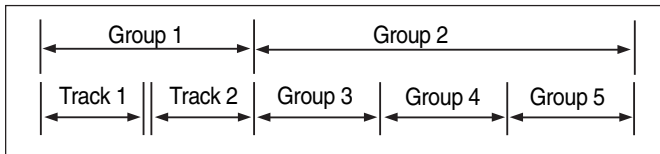

On a JPEG disc, each still picture is recorded as a file. Files are usually grouped into a group (folder). Groups can also include another groups, creating hierarchical folder layers. This system can recognize up to 150 files per group, and up to 99 groups per disc (up to 14,850 files).

- If there is any type of files other than JPEG files in a folder, those files are also counted in the total number of 150.

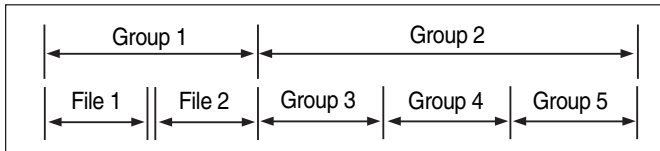

## Playback Control function (PBC) —Only for VCD and SVCD

The Playback Control function allows you to enjoy menu-driven operation and high-resolution still images with a resolution four times greater than moving pictures.

### • High-resolution still image display

You can display high-quality images which are four times clearer than moving pictures.

### • Menu-driven playback

A selection menu is displayed when you start playing a VCD or SVCD disc with the Playback Control function. The selection menu shows a list of numbers to pick from. Some discs may show moving pictures or a divided screen. You can interact with the screen using a menu display to select and play an entry.

The illustration below shows the basic features of menu driven playback. See page 35 for details about using the menu.

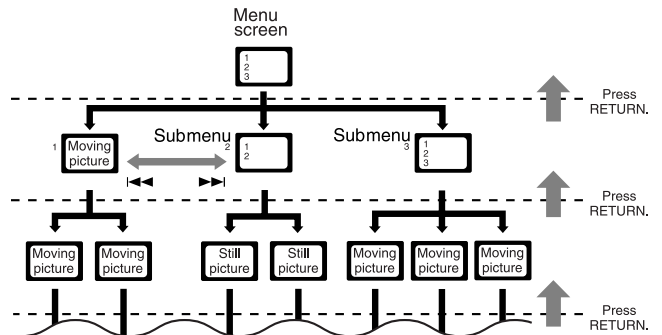

### NOTE:

While operating a VCD or SVCD using the menu, some of the functions, such as repeat play, may not work.

### ! IMPORTANT:

Before playing a disc, make sure of the following...

- Check the connection with the TV.
- Turn on the TV and select the correct input mode on the TV to view the pictures or on-screen information on the TV screen.

! If  appears on the TV screen when pressing a button, the disc cannot accept an operation you have tried to do, or information required for that operation is not recorded on the disc.

**NOTICE:** In some cases, without showing , operations will not be accepted.

# Getting started

## Connections

- **Do not connect the AC power cord until all other connections have been made.**
- Since different components often have different terminal names, carefully read the instructions supplied with the component you are going to connect.

### Connecting a TV

To view pictures and on-screen displays, connect a TV to the center unit.

- Distortion of picture may occur when connecting to a TV through a VCR, or to a TV with a built-in VCR.
- You need to set "MONITOR TYPE" on the PICTURE menu correctly according to the aspect ratio of your TV. See page 53.

#### ■ Selecting the color system

This system is compatible with the PAL and NTSC systems. Set the VIDEO OUT SELECT switch on the rear panel in standby mode to match the color system of your TV. Also make sure that the color system of a DVD, VCD, or SVCD disc labeled on the package matches your TV.

- If you use a multi-system TV, by setting "MONITOR TYPE" on the PICTURE menu to an appropriate "MULTI" option, the system outputs a video signal by the same format recorded on the disc (i.e. if you play an NTSC disc, the system outputs a signal by the NTSC format) regardless of the VIDEO OUT SELECT switch setting. See page 53.

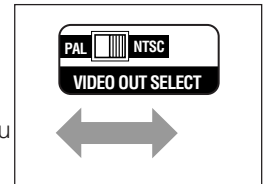

#### ■ Connecting a TV

Connect a TV using one of the following.

- You can get a better picture quality in the order—Component video > S-video > Composite video.

##### • Through the component video jacks

- Connect "Y" to "Y," "PB" to "PB," and "PR" to "PR" correctly.
- If your TV supports the progressive video input, you can enjoy a high quality picture by making the progressive scanning mode active. See page 19.

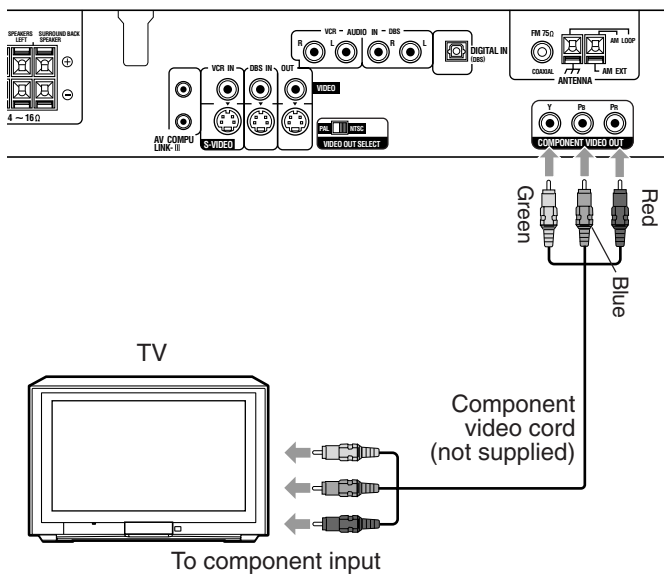

##### • Through the S-video jacks

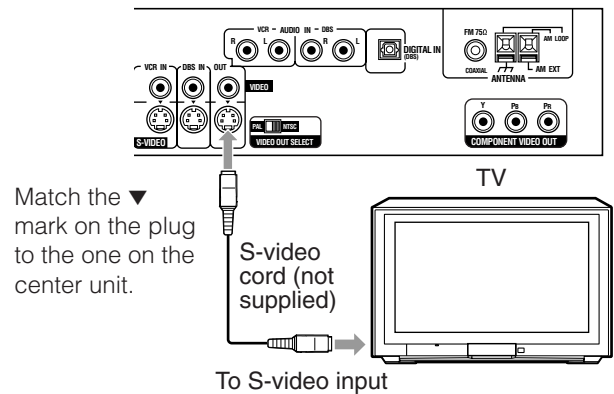

##### • Through the composite video jacks

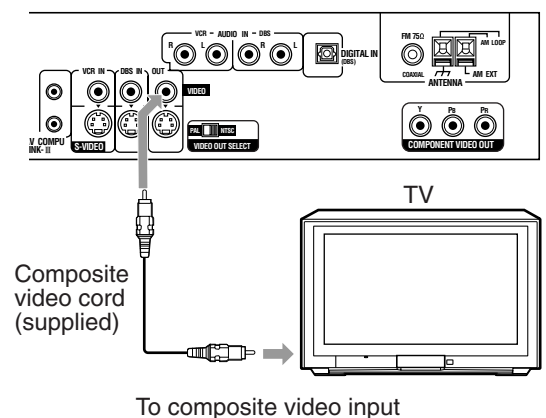

#### NOTES:

- If the component video input jacks of your TV are of the BNC type, use a plug adapter to convert the pin plugs to BNC plugs (not supplied).
- After connecting your TV, select the video output jack type you watch the DVD playback (see page 25).

# Getting started

## Connecting the AM and FM antennas

- Make sure the antenna conductors do not touch any other terminals, connecting cords, and power cords. This could cause poor reception.

### ■ AM loop antenna

#### Setting up AM loop antenna

Attach the AM loop to its base by snapping the tabs on the loop into the slot in the base.

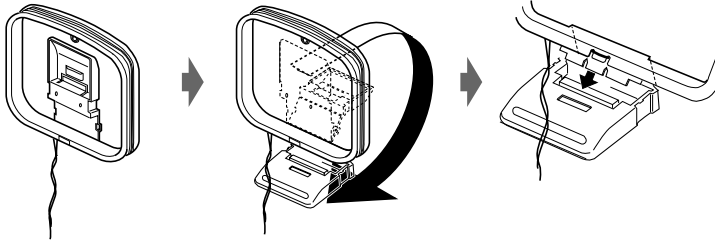

If the antenna cord is covered with vinyl, remove the vinyl by twisting it as shown.

Single vinyl-covered wire (not supplied)

#### If reception is poor:

Connect a single vinyl-covered wire to the AM EXT terminal while keeping the AM loop antenna connected.

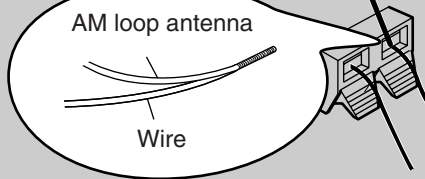

#### Connecting AM loop antenna

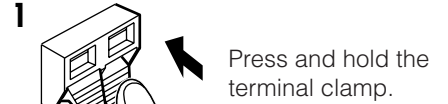

1 Press and hold the terminal clamp.

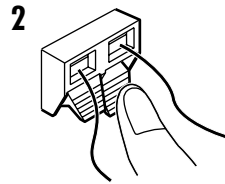

2 Insert the antenna cord.

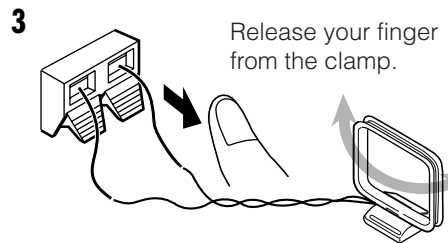

3 Release your finger from the clamp.

- Turn the loop until you have the best reception.

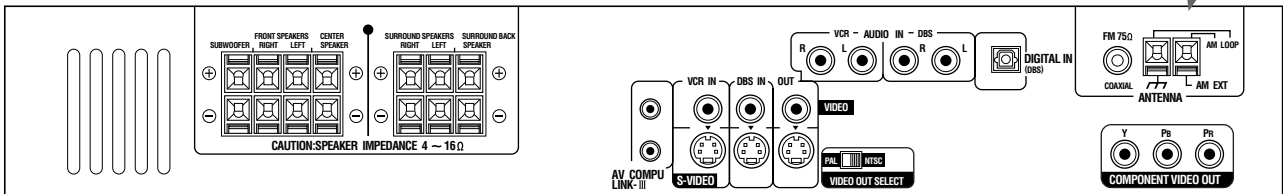

## ■ FM antenna

### Connecting the supplied FM antenna

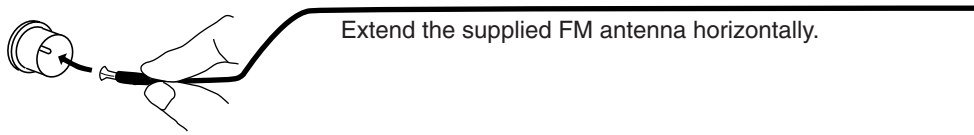

**If reception is poor:**  
Connect an outdoor FM antenna with the standard type (coaxial) connector.

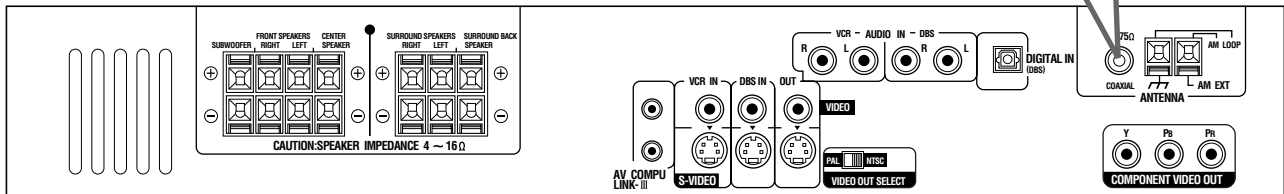
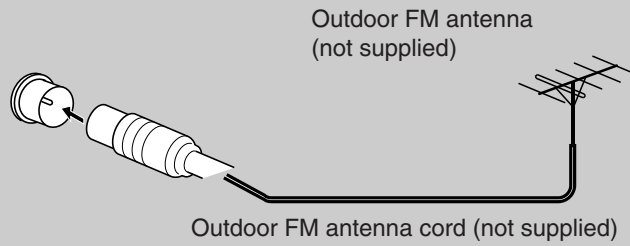

### NOTES:

- Disconnect the supplied FM antenna before attaching a 75 Ω coaxial connector (the kind with a round wire going to an outdoor antenna).
- We recommend that you use a coaxial cable (not supplied) to the FM antenna, since it is well-shielded against interference.

# Getting started

## Connecting the satellite speakers and subwoofer

Connect the supplied satellite speakers and subwoofer.

### Speaker layout diagram

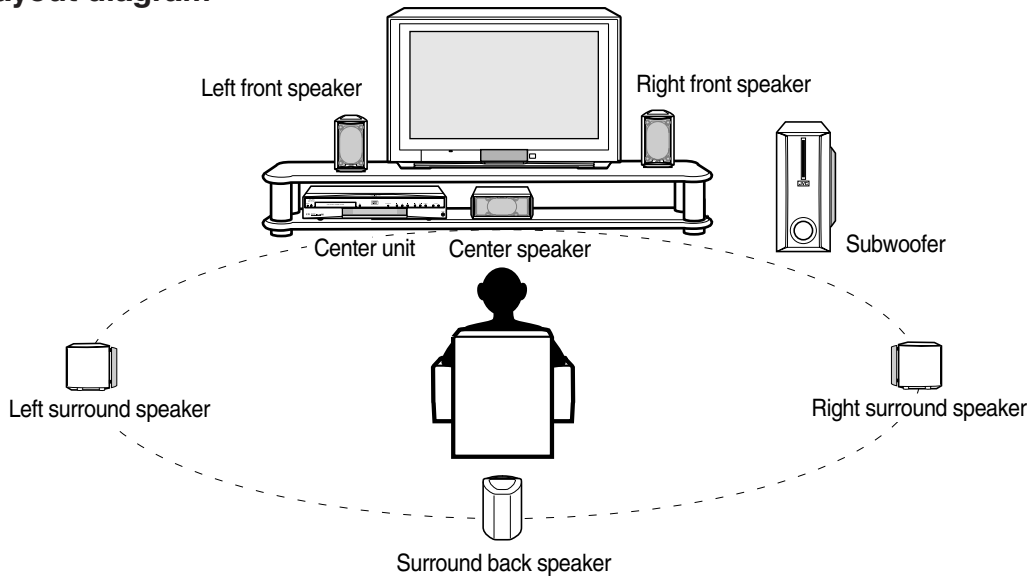

When placing the speakers, to obtain the best possible sound, you need to place all satellite speakers at the same distance from the listening position with the front of each speaker faced toward the listener.

**When you cannot place them at the same distance from the listening position, you can make adjustment as if those speakers are placed at the best position. See pages 25 and 55.**

- Place the subwoofer on the front right side of the television. If you place the subwoofer on the left side of the television, the screen color on the television may be distorted.

### NOTES:

- Although the satellite speakers and the subwoofer are magnetically shielded, the TV screen may be affected. In this case, place the speakers at least 10 cm away from the TV.
- For safety reasons, always ensure sufficient space behind the subwoofer.
- When you place the satellite speakers on a relatively high position, such as on the top of your bookshelf, place them on a flat and level surface.

### ■ Before connecting the speaker cord

If the speaker cord is covered with vinyl, remove the vinyl by twisting it as shown to the right.

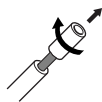

### ■ Inserting the speaker cord into the speaker terminals

**1** Press and hold the terminal clamp.

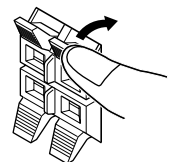

**2** Insert a speaker cord.

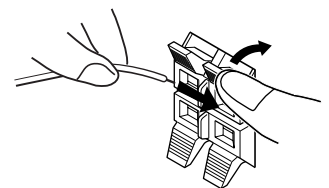

**3** Release your finger from the terminal clamp.

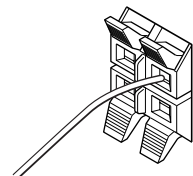

**! CAUTION:**

- When you do not use the supplied speakers but connect other (larger) speakers, use the speakers with the SPEAKER IMPEDANCE indicated by the speaker terminals on the rear panel of the center unit.
- DO NOT connect more than one speaker to one speaker terminal.

**Satellite speakers:**

- 1** Insert mini plugs on the speaker cords into the jacks on the rear of each speaker.
- 2** Connect the white cord to the red (+) terminal and the black cord to the black (-) terminals.

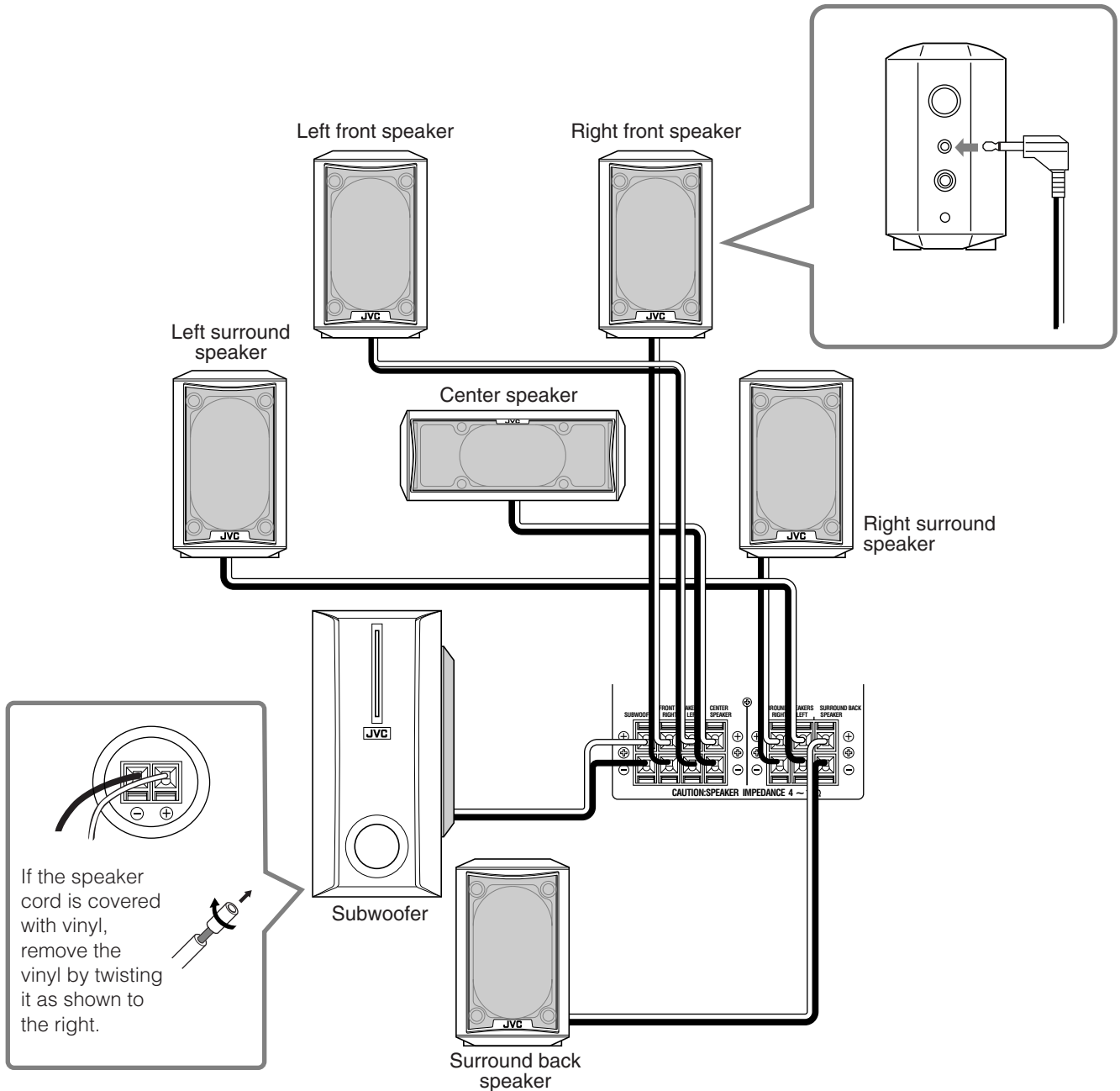

**Subwoofer:**

Connect the white cord to the red (+) terminal and the black cord to the black (-) terminals.

**NOTES:**

- The grills for the satellite speakers are removable. Do not apply any force to the satellite speaker grills to prevent damaging them.
- The grill for the subwoofer is not removable.

# Getting started

## Installing the satellite speakers on the wall

Using the supplied satellite speaker wall brackets, you can fix the surround speakers on the wall.

### ! CAUTION:

When attaching the brackets on the wall, have them attached on the wall by a qualified person.

DO NOT attach the brackets on the wall by yourself to avoid an unexpected damage due to their falling from the wall, caused by incorrect attachment or weakness of the wall.

### Location of attachment to the wall:

Take care when selecting a location for attaching the surround speakers on the wall. Injury to personnel or damage to equipment may result if the speakers are attached in a location which interferes with daily activities.

### Attaching speakers to the brackets

- 1 Attach the brackets to the surround speakers using the supplied screws.

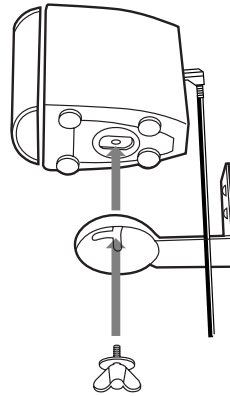

- 2 Adjust the angle of the speakers.

Loosen the screw slightly, make an adjustment, and then tighten the screw firmly.

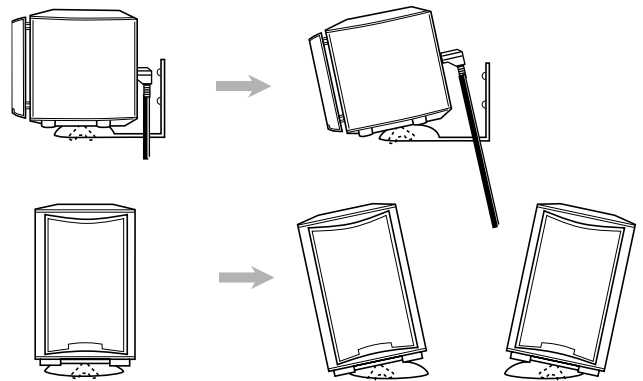

### ! CAUTION:

Failures to tighten the screws firmly may cause injury to personnel or damage to the components.



## Connecting video components

You can enjoy the picture and sound from VCR and DBS tuner through the system.

### ■ VCR connection

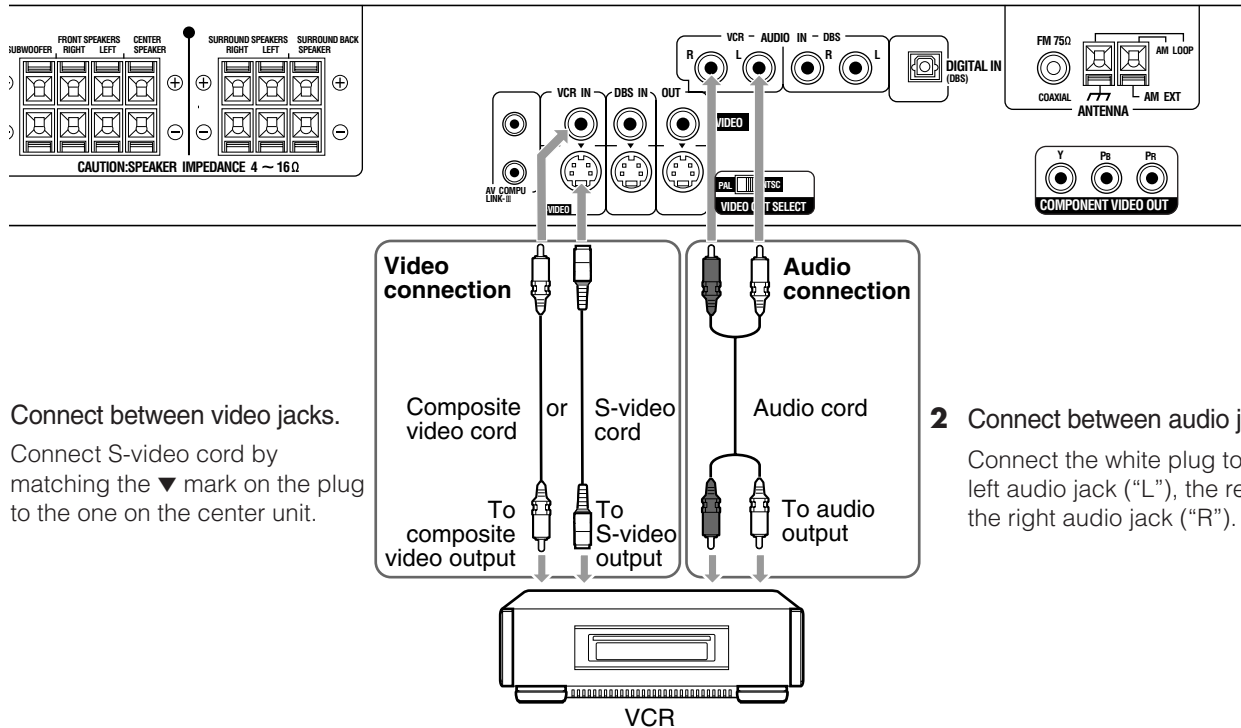

### ■ DBS tuner connection

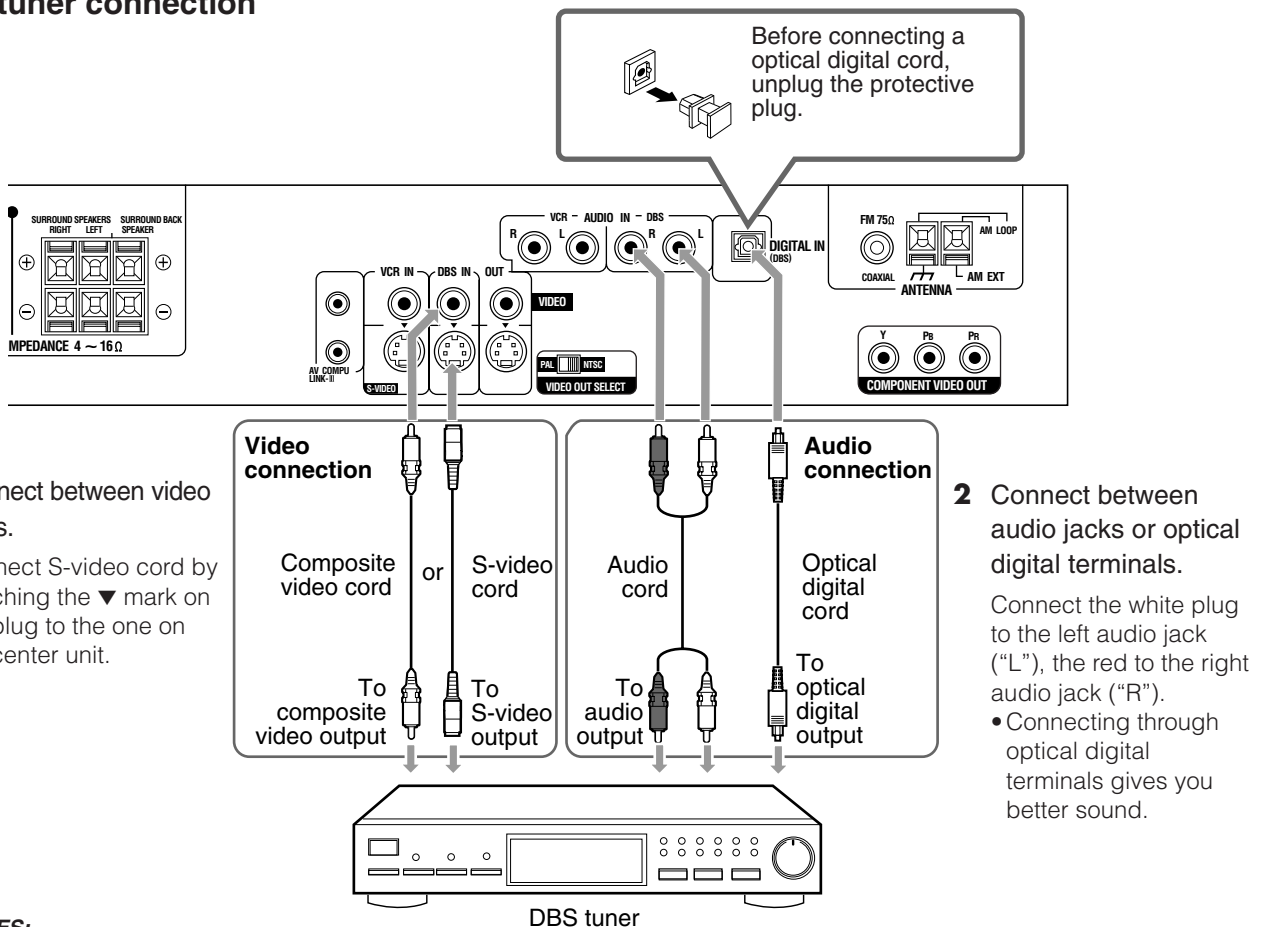

#### NOTES:

- Signal input through the S-video jacks is output from the composite video jacks and S-video jacks, and the signal input through the composite video jacks is only output from the composite video jacks. To watch the picture from the VCR and the DBS tuner, you also need to connect your TV to the appropriate video output jack—the composite video jack or S-video jack. You cannot see the picture from the VCR and the DBS tuner when connecting your TV to the component video output jacks only.
- When connecting through both the composite video jacks and S-video jacks, S-video signal is selected as the video signal.

# Getting started

## Connecting the power cord

Make sure that all connections have been made before plugging the power cord.

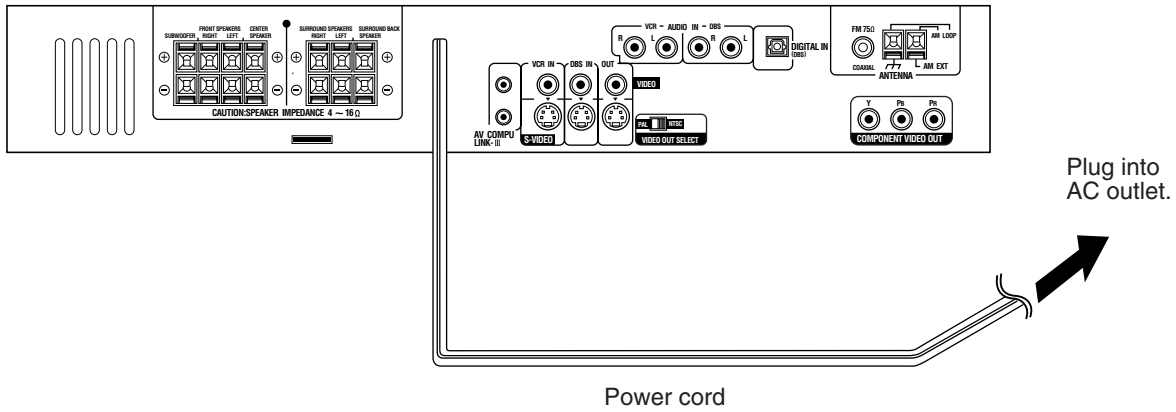

### ! CAUTIONS:

- Disconnect the power cord before cleaning or moving the system.
- Do not touch the power cord with wet hands.
- Do not pull on the power cord to unplug the cord.  
When unplugging the cord, always grasp the plug so as not to damage the cord.

### NOTES:

- Keep the power cord away from the connecting cords. The power cord may cause noise or screen interference.
- The preset settings such as preset stations, and sound adjustment may be erased within a few days in the following cases:
  - When you unplug the power cord.
  - When a power failure occurs.

# Using the remote control

## Putting batteries in the remote control

Before using the remote control, put in two supplied batteries first.

- 1 On the back of the remote control, remove the battery cover.
- 2 Insert batteries.
  - Make sure to match the polarity: (+) to (+) and (-) to (-).
- 3 Replace the cover.

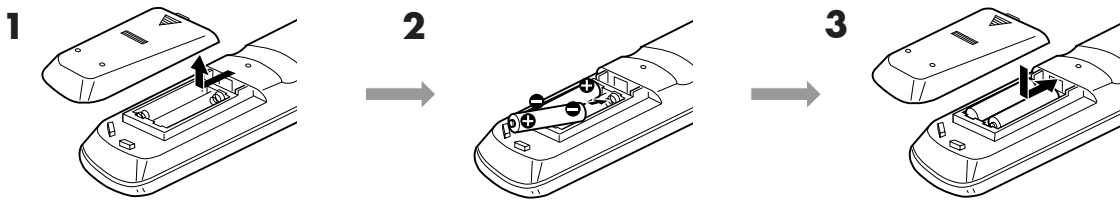

If the range or effectiveness of the remote control decreases, replace the batteries. Use two R6S (SUM-3)/AA (15F) type dry-cell batteries.

### ! CAUTION:

Follow these precautions to avoid leaking or cracking batteries:

- Place batteries in the remote control so they match the polarity: (+) to (+) and (-) to (-).
- Use the correct type of batteries. Batteries that look similar may differ in voltage.
- Always replace both batteries at the same time.
- Do not expose batteries to heat or flame.

## Operating the system using the remote control

Aim the remote control directly at the remote sensor on the center unit. The effective distance between the remote control and the remote sensor on the center unit is about 7 m.

- You can also operate other components using the remote control.
  - To operate your TV, see page 62.
  - To operate your VCR, CATV converter or DBS tuner, see pages 63 and 64.To control other components, aim the remote control directly at the remote sensor on each target component. Refer also to their instruction manuals.
- To operate the remote control properly, do not hide the remote sensor by placing any obstruction.

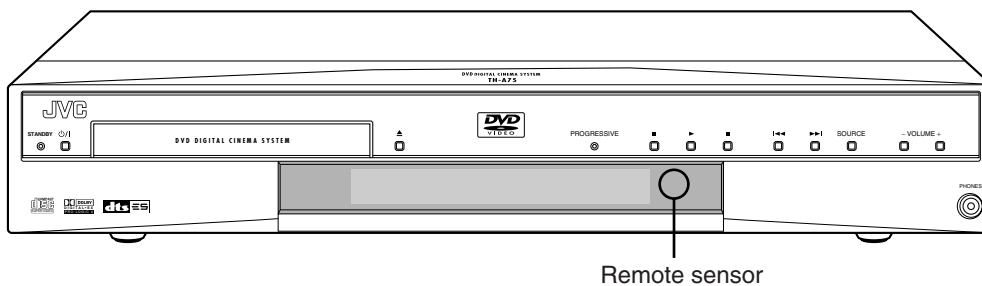

# Basic operations

This section mainly explains common basic operations.

- Turn on your TV and select the correct input mode on the TV if necessary.
- You can operate your TV using the remote control supplied with this system (see page 62).

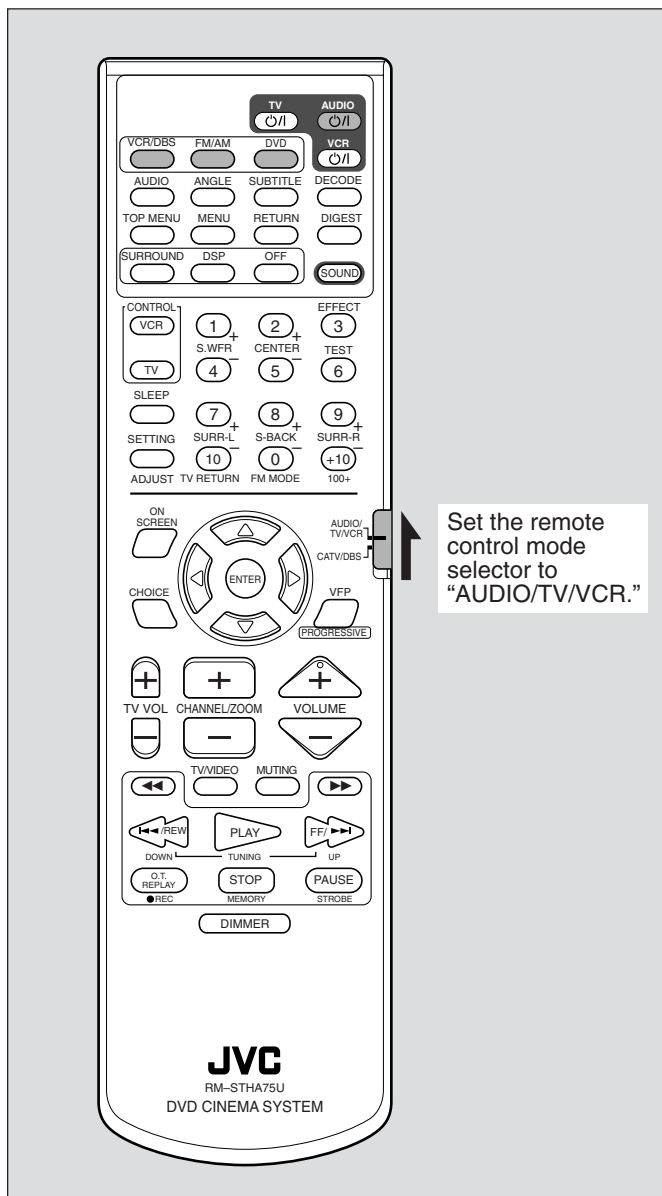

## NOTES:

- A small amount of power is consumed even though the power is turned off (standby mode). Remove the power cord from the AC outlet to turn off the power supply completely.
- The STANDBY lamp continues to light up for a while after unplugging the power cord. This is not a malfunction of the system.

## Selecting the source to play

From the remote control:

Press one of the source selecting buttons (DVD, FM/AM or VCR/DBS).

- DVD**: Select the DVD player.
- FM/AM**: Select an FM or AM broadcast.
  - Each time you press the button, the band alternates between FM and AM.
- VCR/DBS**: Select a VCR connected to the VCR IN jacks or DBS tuner connected to the DBS IN jacks.
  - Each time you press the button, VCR and DBS changes alternately.

On the center unit:

Press SOURCE repeatedly.

Each time you press the button, the source changes as follows.

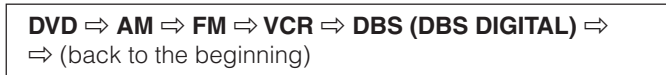

Ex.: When "AM" is selected.

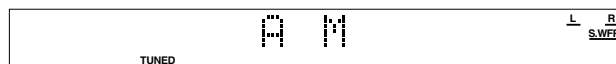

## Turning on the system

Press **AUDIO** on the remote control or (standby/on) on the center unit.

The STANDBY lamp goes off and the last selected source activates.

- Pressing on the center unit or one of the source selecting buttons on the remote control also turns on the system.

### To turn off the system

Press **AUDIO** on the remote control or (standby/on) on the center unit again.

The STANDBY lamp lights up.

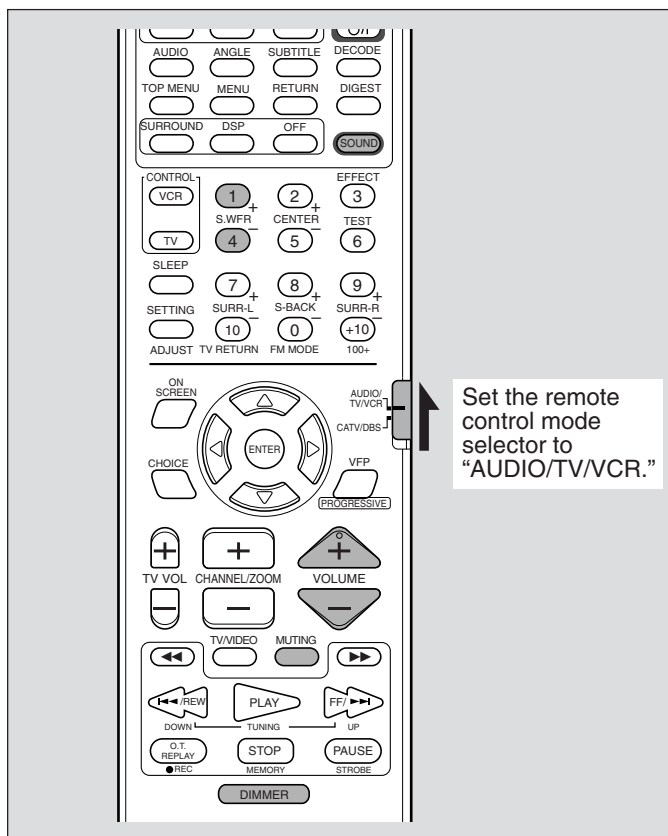

**! CAUTION:**

Be sure to turn down the volume:

- Before connecting or putting on headphones, as high volume can damage both the headphones and your hearing.
- Before removing headphones, as high volume may output from the speakers.

## Adjusting the output level of subwoofer

You can adjust the output level of the subwoofer. Once you have adjusted the output level of the subwoofer, the adjustment is memorized for each source. You can also adjust the output level using the on-screen menu (see page 55).

From the remote control ONLY:

- 1 Press **SOUND**.
- 2 Press **S.WFR +/-** to adjust the output level of the subwoofer (-10 dB to +10 dB).

## Turning off the sound temporarily

From the remote control ONLY:

Press **MUTING**.

"MUTING" appears on the display and the volume turns off.

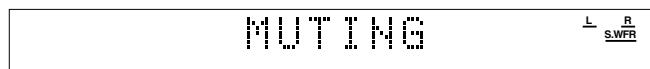

**To restore the sound**

Press **MUTING** again.

- Pressing **VOLUME +/-** also restores the sound.

## Adjusting the volume

You can adjust the volume level within the range of "0" (minimum) to "70" (maximum).

Press **VOLUME +/-**.

- Press **+** to increase the volume.
- Press **-** to decrease the volume.

The volume level appears on the display.

**! CAUTION:**

Always set the volume to the minimum before starting any source.

If the volume is set at its high level, the sudden blast of sound energy can permanently damage your hearing and/or ruin your speakers.

### ■ Listening with headphones

Connect a pair of headphones to the PHONES jack on the center unit. This cancels the Surround/DSP mode (see pages 27 to 31) currently selected, deactivates speakers, and activates the HEADPHONE mode.

- Disconnecting a pair of headphones from the PHONES jack cancels the HEADPHONE mode and activates speakers and previously selected Surround/DSP mode.

**HEADPHONE mode**

When using the headphones, the following signals are transmitted regardless of your speaker setting:

—For 2 channel sources, the front left and right channel signals are output directly from the left and right headphones.

—For multi-channel sources, the front left and right, center and surround channel signals are down-mixed and then output from the headphones.

You can enjoy down-mixed multi-channel sound source using the headphones.

## Adjusting the brightness

You can dim the indications on the display.

From the remote control ONLY:

Press **DIMMER**.

Each time you press the button, the brightness level changes as follows.



**DIMMER 1** :Dims the display and the blue light on the both sides of the display.

**DIMMER 2** :Dims the display and turns off the blue light on the both sides of the display.

**OFF** :Lights up the display and the blue light on the both sides of the display.

# Basic operations

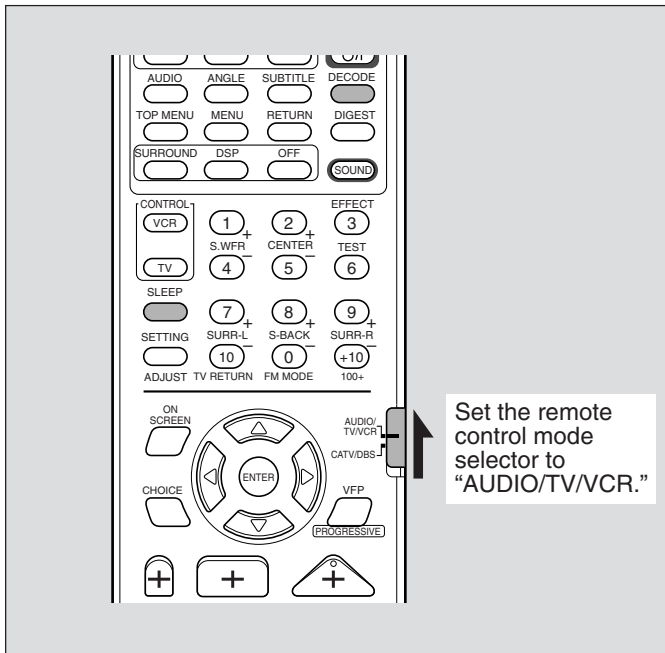

## Changing the analog/digital input mode and decoding mode

When playing software encoded with Dolby Digital or DTS Digital Surround, the following symptoms may occur:

- Sound does not come out at the beginning of playback.
- Noise comes out while chapters or tracks are being searched for or skipped over.

To fix these problems, set the correct decoding mode.

### From the remote control ONLY:

Press **DECODE** to select the digital input mode when DVD or DBS tuner is selected as the source.

Each time you press the button, the input mode changes as follow.

### When DVD is selected as the source:

**AUTO/PCM** ⇒ **DOLBY D** ⇒ **DTS** ⇒ (back to the beginning)

### When DBS tuner is selected as the source:

**ANALOG** ⇒ **AUTO/PCM** ⇒ **DOLBY D** ⇒ **DTS** ⇒ (back to the beginning)

- When you want to hear digital sound reproduced, connect the center unit and the component through the optical digital terminals.

**ANALOG** :Select when the DBS tuner is connected to AUDIO IN jacks.

### For Digital Connection

**AUTO/PCM** :Normally select this for the digital input mode. The system automatically detects the incoming signals.

**DOLBY D** :Select when playing software encoded with Dolby Digital or Dolby Digital EX.

**DTS** :Select when playing software encoded with DTS Digital Surround or DTS-ES.

The following are the digital signal indicators on the display to indicate what type of signal comes into the system (see also page 30).

- LINEAR PCM** :Lights when Linear PCM signal comes in.
- DIGITAL EX** :Lights when Dolby Digital EX signal comes in.
- DIGITAL** :
  - Lights when Dolby Digital signal comes in.
  - Flashes when "DOLBY D" is selected for software not encoded with Dolby Digital.
- dts** :
  - Lights when DTS or DTS-ES signal comes in.
  - Flashes when "DTS" is selected for software not encoded with DTS.

### NOTES for the digital input mode:

- If the incoming signal cannot be recognized when selecting "AUTO/PCM," no digital signal indicators light up on the display.
- Turning off the system or changing the source returns the input mode to "AUTO/PCM" automatically.

## Turning off the power with the sleep timer

Using the sleep timer, you can fall asleep while listening to music.

### From the remote control ONLY:

Press **SLEEP**.

Each time you press the button, the shut-off time changes as follows:

**0min** (cancelled) ⇒ **10min** (minutes) ⇒ **20min** ⇒ **30min** ⇒ **60min** ⇒ **90min** ⇒ **120min** ⇒ **150min** ⇒ (back to the beginning)

Ex.: When "150min" is selected.



### To check the remaining time until the shut-off time

Press **SLEEP** once.

The remaining time until the shut-off time appears on the display for a while.

### To change the remaining time until the shut-off time

Press **SLEEP** repeatedly to change the shut off time.

- Each time you press the button, the shut-off time changes.

### To cancel the sleep timer

Press **SLEEP** repeatedly until "0min" appears on the display window.

- Turning off the power also cancels the sleep timer.

### NOTES:

- When DVD is selected as the source to play, this system can also turn off automatically if playback is not restarted within the time you have specified (Auto Standby). See page 56.
- If the shut-off time set by Auto Standby comes earlier than the one set by the sleep timer, Auto Standby takes effect.

## Storing basic adjustments—auto memory

This system stores sound settings for each source:

- When you turn off the power, and
- When you change the source

The following can be stored:

- The adjustment for the front speakers—balance, bass, and treble (see pages 26 and 54)
- Low frequency effect attenuator (see pages 26 and 54)
- Subwoofer audio position (see page 26)
- Speaker and subwoofer output level (see pages 17, 32 and 55)\*
- Bass boost setting (see page 26)\*
- Surround and DSP modes selection (see page 31)\*
- DSP effect level (see page 32)\*



### NOTE:

For the items marked “\*,” you can assign a different setting for each source including FM and AM.

## Changing the scanning mode

This system supports the progressive scanning system (525p\*) as well as the conventional interlaced scanning system (525i\*).

If your TV equipped with component jacks supports the progressive video input, you can enjoy a high quality picture by making the progressive scanning mode active.

- Refer also to the instruction manuals supplied with your TV.
- If your TV equipped with component jacks does not support the progressive video input, do not change the scanning mode to the progressive scanning mode.

### From the remote control ONLY:

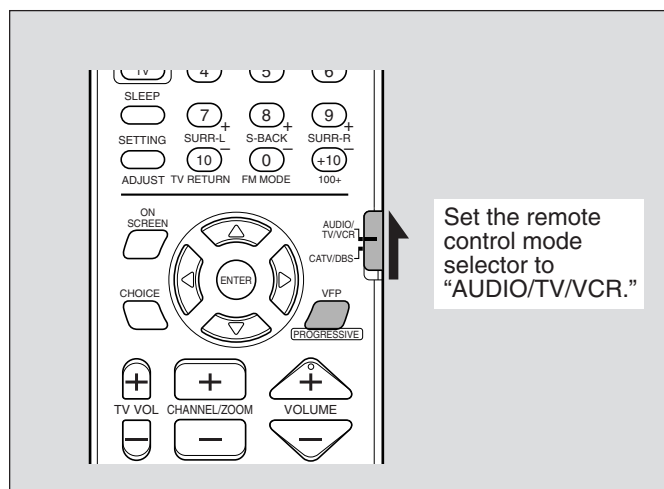

Press and hold **PROGRESSIVE** for 5 seconds.

Each time you press and hold the button, the scanning mode alternates between “PROGRESSIVE” and “INTERLACE.”

### INTERLACE

:Select only when your TV equipped with component jacks supports the interlaced video input.

### PROGRESSIVE

:Select when your TV equipped with component jacks supports the progressive video input.

The PROGRESSIVE lamp on the center unit lights up when you select “PROGRESSIVE” as the scanning mode.



### NOTES:

- When “PAL” is selected on the VIDEO OUT SELECT switch (see page 7), the scanning mode is fixed to “INTERLACE.” So the scanning mode cannot be changed.
  - There are some progressive TVs and High-Definition TVs that are not fully compatible with this system, resulting in the unnatural picture when playing back a DVD in the progressive scanning mode. In such a case, change the scanning mode to “INTERLACE.” To check the compatibility of your TV, contact your local JVC customer service center.
  - All JVC progressive TVs and High-Definition TVs are fully compatible with this system.
- \* 525p and 525i indicate the number of scanning lines and scanning format of an image signal.
- 525p indicates 525 scanning lines with progressive format.
  - 525i indicates 525 scanning lines with interlaced format.

### About scanning system

To display video on the TV screen, the conventional scanning method is called “Interlaced scanning.” With this method, only half of the horizontal lines are displayed at a time. So two fields complete a single picture (frame);

i.e., the first field, containing all the odd-numbered lines, is displayed followed by the second field, containing all the even-numbered lines.

On the other hand, the Progressive scanning system scans all horizontal lines at a time, so you can double the number of scanning lines displayed at a time, resulting in a flicker-free, high-density picture.

To enjoy the progressive scanned video, a monitor (or TV or projector) to be connected to the unit must have the Progressive inputs.

Depending on the material source format, DVD VIDEO can be classified into two types; film source and video source (note that some DVD VIDEO contain both film source and video source). Film sources are recorded as 24-frame-per-second information, while (NTSC) video sources are recorded as 30-frame-per-second (60-field-per-second interlaced) information.

When this system plays back a film source material, uninterlaced progressive output signals are created using the original information. When a video source material is played back, the unit interleaves lines between the interlaced lines on each to create the pseudo uninterlaced picture and outputs as the progressive signal.



# Basic DVD player operations

For more details about DVD player operations, see pages 33 to 45.

For MP3 playback, see pages 46 and 47. For JPEG disc playback, see pages 48 and 49.

- Before using the remote control, press **DVD** to change the remote control operation mode.
- Turn on your TV and select the correct input mode on the TV before turning on the system.

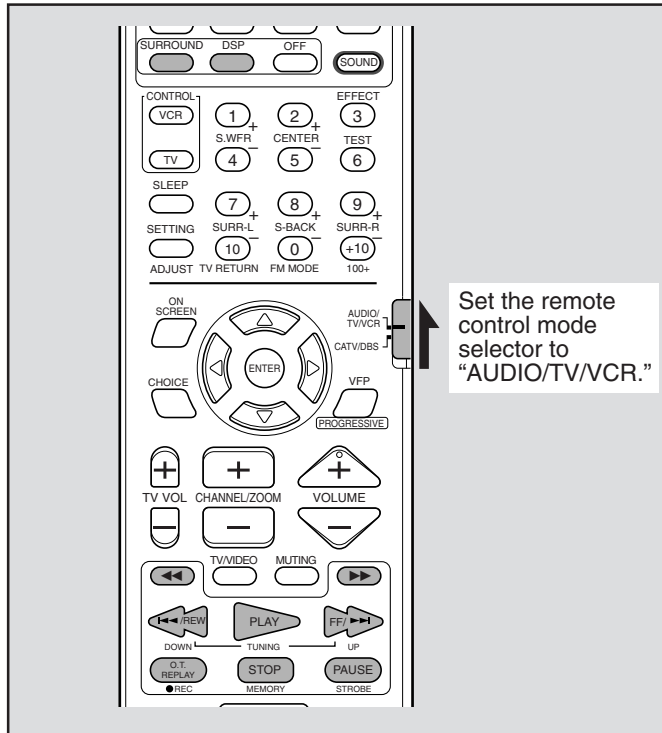

## 1 Press **▲** on the center unit.

The system turns on and the disc tray comes out. The STANDBY lamp goes off.

- To change the subtitle or audio language, see page 37.

## 2 Load a disc onto the disc tray with the label side up.

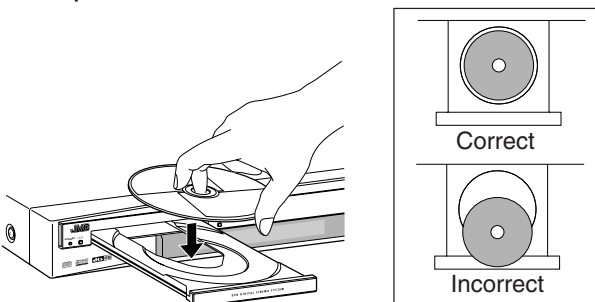

## 3 Start playback.

From the remote control: Press **PLAY**.

On the center unit: Press **▶**.

The disc tray closes and the system starts playing back the loaded disc.

- You can also close the disc tray by pressing **▲** on the center unit.

## 4 Adjust the volume.

- See page 17 for details.

## 5 Activate preferred Surround or DSP mode.

From the remote control ONLY:

Press **SURROUND** or **DSP**.

- See page 31 for details.

### To stop the playback.

From the remote control: Press **STOP**.

On the center unit: Press **■**.

### To eject the loaded disc

Press **▲** on the center unit.

### To stop the playback temporarily

From the remote control: Press **PAUSE**.

On the center unit: Press **■**.

- Pressing **PLAY** or **▶** on the center unit starts playback again.

### To move back the playback by 10 seconds (DVD only)—one touch replay

From the remote control ONLY: Press **O.T. REPLAY**.

The previous 10-second picture is replayed.

### NOTES:

- One touch replay works between chapters in the same title.
- One touch replay may not work for some DVDs.

### To fast-forward (or fast-reverse) the playback

From the remote control: Press **▶▶** (or **◀◀**).

Each time you press the button, fast-forward (or fast-reverse) speed changes as follow:

**▶▶ x2** ⇒ **▶▶ x5** ⇒ **▶▶ x10** ⇒ **▶▶ x20** ⇒ **▶▶ x60** \*  
(or **◀◀ x2** ⇒ **◀◀ x5** ⇒ **◀◀ x10** ⇒ **◀◀ x20** ⇒ **◀◀ x60** \*)

\* **▶▶ x60** and **◀◀ x60** are only available for DVD.

- Pressing **PLAY** resumes normal play.

On the center unit: Press and hold **▶▶** (or **◀◀**).

If you press and hold the button, fast-forward (or fast-reverse) speed changes as follow:

**▶▶ x5** ⇒ **▶▶ x20** (or **◀◀ x5** ⇒ **◀◀ x20** )

- Releasing **▶▶** (or **◀◀**) resumes normal play.

### NOTES:

- No sound comes out while fast-forwarding (or fast-reversing) a DVD, VCD or SVCD.
- This function is not available for some DVDs.

### To locate the beginning of the particular chapter or track

Chapter on DVD :During playback

Track on VCD/SVCD:During playback with the PBC function deactivated or while stopped

Track on Audio CD :During playback or while stopped

From the remote control: Press **FF/▶▶** (or **◀◀/REW**)

On the center unit: Press **▶▶** (or **◀◀**).

### NOTE:

This function is not available for some DVDs.



**To select a particular title, chapter or track using number buttons**

- Title on DVD :While stopped
- Chapter on DVD :During playback
- Track on VCD/SVCD :During playback with the PBC function deactivated or while stopped
- Track on Audio CD :During playback or while stopped

From the remote control ONLY: Press the number buttons.

- To select 3, press 3.
- To select 14, press +10 then 4.
- To select 24, press +10, +10, then 4.
- To select 40, press +10, +10, +10 then 10.

The selected title, chapter, or track number starts playing.

**NOTE:**

The number buttons may be also used to select an item on the menus of DVD or of VCD/SVCD with PBC function.

**Resume playback function (see page 56):**

If you turn off the power while playing back a disc, the position where the playback has been stopped is stored. The RESUME indicator lights up on the display when the resume function is activated.

To resume playback from that position, press DVD or PLAY on the remote control.

- The resume playback function does not work for Audio CDs.

**Preventing screen burn-out—screen saver function**

A TV screen may be burned out if a static picture is displayed for a long time. To prevent this, the system automatically dims the screen if a static picture is displayed for over 5 minutes—the screen saver function.

- Pressing any button will cancel the screen saver function.
- If you do not want to use the screen saver function, see page 53.

**About the indications on the display**

While playing back a disc, the playback information appears on the display.

Ex.: When playing back a DVD

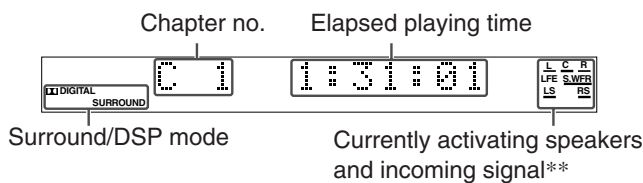

Ex.: When playing back an Audio CD

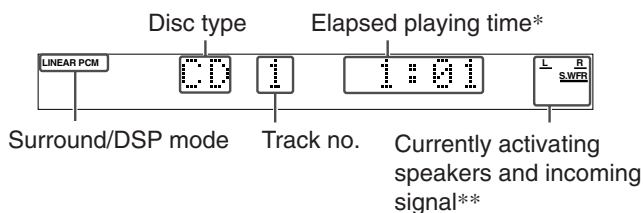

**NOTES:**

- You can change the display pattern of time information. See page 34.
- The current disc type information appears as follows:
  - “VCD”: shows a VCD or SVCD is loaded.
  - “CD”: shows an Audio CD is loaded.
- \* When a VCD or SVCD with PBC function is played, the time information does not appear, but “PBC” appears.
- \*\* See page 30 for details.

# Tuner operations

You can browse through all the stations or use the preset function to go immediately to a particular station.

- **Before using the remote control, press FM/AM to change the remote control operation mode.**

## Setting the AM tuner interval spacing

Some countries space AM stations 9 kHz apart, and other countries use 10 kHz spacing.

- 9 kHz interval spacing is the initial setting.

On the center unit ONLY:

### ■ When AM is selected as the source

#### To select the 10 kHz interval

Press and hold **II**, then press **▶▶**. "10k STEP" appears on the display window. Now the 10 kHz interval is selected.

#### To select the 9 kHz interval

Press and hold **■**, then press **▶▶**. "9k STEP" appears on the display window. Now the 9 kHz interval is selected.

## Tuning in to stations manually

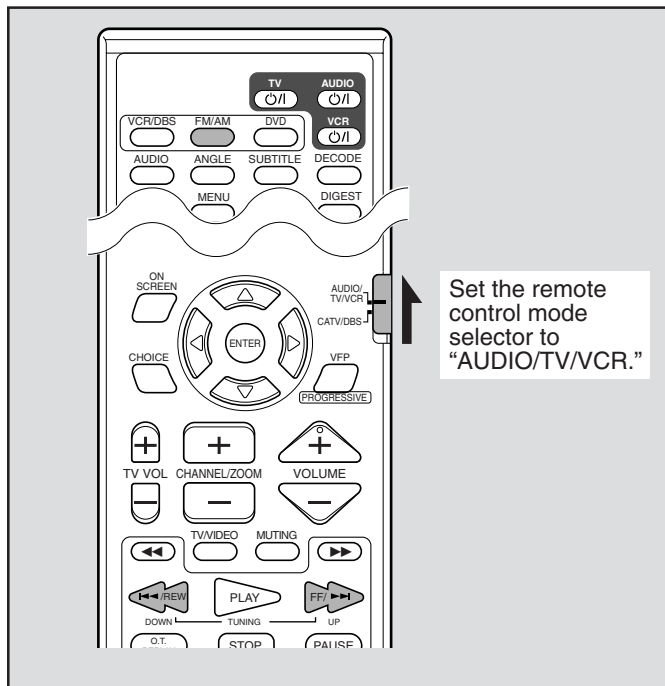

From the remote control ONLY:

### 1 Press FM/AM repeatedly to select the band.

Each time you press the button, the band alternates between FM and AM.

The selected band appears on the display, then the last received station appears.

Ex.: When AM is selected

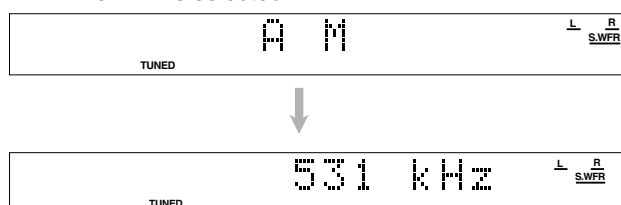

### 2 Press TUNING UP or DOWN repeatedly until you find the frequency you want.

- TUNING UP :Increases the frequency.
- TUNING DOWN :Decreases the frequency.

When you hold the button down, the system starts searching for stations and stops when a station of sufficient signal strength is tuned in to.

#### NOTES:

- When a station of sufficient signal strength is tuned in, the TUNED indicator lights up on the display.
- When an FM stereo program is received, the ST indicator lights up.

## Using preset tuning

Once a station is assigned to a channel number, the station can be quickly tuned in. You can preset 30 FM and 15 AM stations.

### ■ To store the preset stations

*Before you start, remember...*

*There is a time limit in doing the following steps. If the setting is canceled before you finish, start from step 2 again.*

From the remote control ONLY:

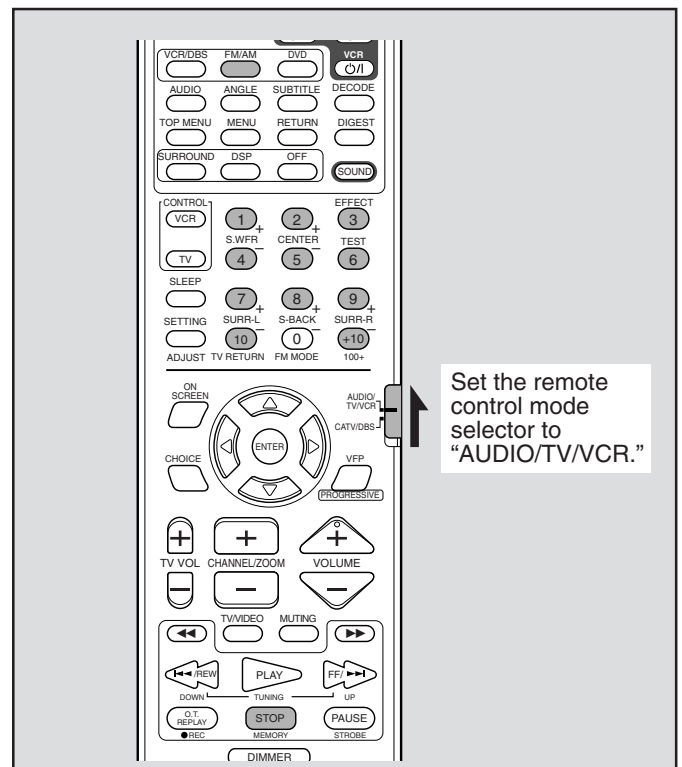

### 1 Tune in to the station you want to preset (see "Tuning in to stations manually").

- If you want to store the FM reception mode for an FM station, select the reception mode you want. See "Selecting the FM reception mode" on page 23.



## 2 Press MEMORY.

The channel number position starts flashing on the display for about 5 seconds.

## 3 Press the number buttons (1–10, +10) to select a channel number while the channel number position is flashing.

The channel number and the CH indicator start flashing.

Ex.:

- For channel number 3, press 3.
- For channel number 14, press +10 then 4.

(For FM stations only)

- For channel number 24, press +10, +10, then 4.
- For channel number 30, press +10, +10, then 10.



## 4 Press MEMORY again while the selected number is flashing on the display.

The selected number stops flashing.

The station is assigned to the selected preset number.

## 5 Repeat steps 1 to 4 until you store all the stations you want.

### To erase a stored preset station

Storing a new station on a already used number erases the previously stored one.

### ■ To tune in to a preset station

From the remote control ONLY:

## 1 Press FM/AM repeatedly to select the band.

Each time you press the button, the band alternates between FM and AM.

## 2 Press the number buttons (1–10, +10) to select a preset channel number.

Ex.:

- For channel number 3, press 3.
- For channel number 14, press +10 then 4.

(For FM stations only)

- For channel number 24, press +10, +10, then 4.
- For channel number 30, press +10, +10, then 10.

## Selecting the FM reception mode

When a stereo FM program currently tuned in is noisy, you can change the FM reception mode to improve the reception.

- You can store the FM reception mode for each preset station. See "Using preset tuning" on page 22.

From the remote control ONLY:

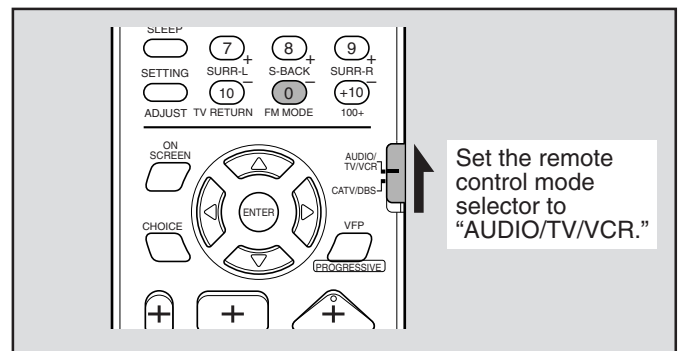

## Press FM MODE while listening to an FM station.

The FM reception mode appears on the display.

Each time you press the button, the FM reception mode alternates between "AUTO MUTING" and "MONO."

### • AUTO MUTING:

When a program is broadcast in stereo, you will hear it in stereo.

When in monaural, you will hear as monaural. This mode is also useful to suppress static noise between stations. The AUTO MUTING indicator lights up on the display.

### • MONO:

Reception will be improved although you will lose the stereo effect. In this mode, you will hear noise until you are tuned in to a station. (The AUTO MUTING indicator also goes off.) The ST indicator goes off from the display.

## Reducing the noise of AM broadcast

When listening to an AM broadcast with noise interference, you can change the Beat Cut mode to reduce the noise.

From the remote control ONLY:

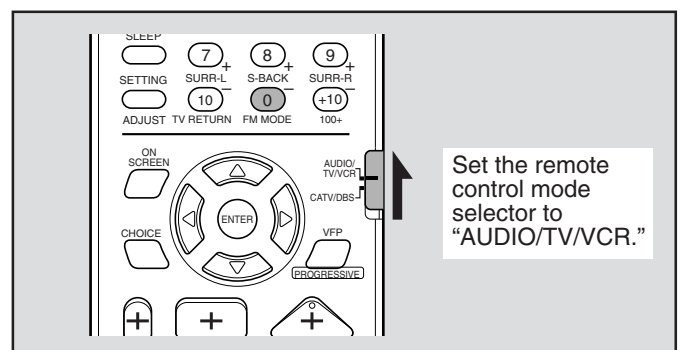

## Press FM MODE while listening to an AM station.

The current Beat Cut mode appears on the display window.

Each time you press the button, the Beat Cut mode alternates between "BEAT CUT 1" and "BEAT CUT 2."

- Choose "BEAT CUT 1" or "BEAT CUT 2" whichever gives you clearer sound.

# Basic settings

Some of the following settings are required after connecting and positioning your speakers, while others will make operations easier.

- You can also set following speakers setting using the choice menu except "EX/ES," "PHASE" and "M.OUT" (see pages 55 and 56).

## Operating procedure

Before you start, remember...

There is a time limit in doing the following steps. If the setting is canceled before you finish, start from step 1 again.

From the remote control ONLY:

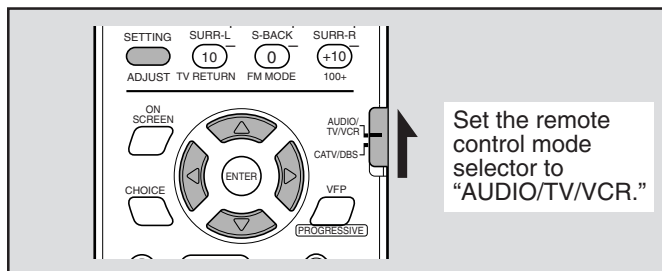

### 1 Press SETTING/ADJUST once.

"SETTING" appears on the display.

- Each time you press SETTING/ADJUST, the function for the button changes as follow.

SETTING → ADJUST → current source →  
(back to the beginning)

### 2 Press Cursor ▼/▲ repeatedly to select the item you want to set while "SETTING" appears on the display.

- Each time you press the button, the item shown on the display changes as follow:

FRNT SP ↔ CNTR SP ↔ SURR SP ↔ BACK SP ↔  
EX/ES ↔ FRNT D ↔ CNTR D ↔ SURR D ↔  
BACK D ↔ CROSS ↔ PHASE ↔ M.OUT ↔  
(back to the beginning)

FRNT SP : LRG

Ex.: "FRNT SP" is selected.

### 3 Press Cursor ►/◀ repeatedly to select the appropriate setting for the item.

Your setting is stored.

## Setting speaker sizes

—FRNT SP (front speaker), CNTR SP (center speaker),  
SURR SP (surround speaker),  
BACK SP (surround back speaker)

Select the sizes for each speaker.

**LARGE** :Select when the cone speaker size is larger than 12 cm.

**SMALL** :Select when the cone speaker size is smaller than 12 cm.

**NO** :(Only for "BACK SP") Select when no speaker is connected.

### ! CAUTION:

When using the supplied speakers, select "SMALL" for each. Selecting "LARGE" will damage the speakers.



### NOTES:

- If you have selected "SMALL" for the front speakers, you cannot select "LARGE" for the center, surround, and surround back speakers.
- If you have selected "SMALL" for the surround speakers, you cannot select "LARGE" for the surround back speaker.

## Selecting the channel number to reproduce multi-channel digital software—EX/ES

You can select 5.1-channel or 6.1-channel reproduction to play back multi-channel (more than 5.1-channel) digital software when the size of the surround back speaker is set to "LARGE" or "SMALL" (see the left). "AUTO" is initial setting.

Select one of the following settings.

- AUTO** :Select to reproduce signal originally recorded.
- When playing back Dolby Digital EX software (bearing the mark , "DOLBY D EX (Dolby Digital EX)" is activated using the surround back speaker.
  - When playing back Dolby Digital 5.1-channel software, "DOLBY D (Dolby Digital)" is activated without using the surround back speaker.
  - When playing back DTS-ES Discrete software (bearing the mark , "ES DSCRETE (DTS-ES Discrete)" is activated using the surround back speaker.
  - When playing back DTS-ES Matrix software (bearing the mark , "ES MATRIX (DTS-ES Matrix)" is activated using the surround back speaker.
  - When playing back DTS Digital Surround 5.1-channel software, "DTS (DTS Digital Surround)" is activated without using the surround back speaker.
- ON** :Select to activate 6.1-channel reproduction using the surround back speaker.
- When playing back Dolby Digital EX software, "DOLBY D EX (Dolby Digital EX)" is activated using the surround back speaker.
  - When playing back Dolby Digital 5.1-channel software, "DOLBY D EX (Dolby Digital EX)" is activated using the surround back speaker. Surround back channel is reproduced from surround signal.
  - When playing back DTS-ES Discrete software, "ES DSCRETE (DTS-ES Discrete)" is activated using the surround back speaker.
  - When playing back DTS-ES Matrix software, "ES MATRIX (DTS-ES Matrix)" is activated using the surround back speaker.
  - When playing back DTS Digital Surround 5.1-channel software, "DTS + NEO:6" is activated using the surround back speaker. Surround back channel is reproduced from surround signal.

- OFF** :Select to activate 5.1-channel reproduction without using the surround back speaker.
- When playing back Dolby Digital EX software or DTS-ES software, the surround back signal is output from the surround speakers mixed with the surround signals.
  - When playing back Dolby Digital or DTS Digital Surround 5.1-channel software, conventional "DOLBY D (Dolby Digital)" or "DTS (DTS Digital Surround)" is activated.

**NOTES:**

- If you have selected "NO" for the surround back speaker (see page 24), you cannot select this setting. 6.1-channel and 5.1-channel software is played back in the same way as "OFF" is selected for above setting.
- When the sound is not output from the surround back speaker even though playing back Dolby Digital EX software (bearing the mark ) setting "EX/ES" to "AUTO," select "ON" instead of "AUTO."

## Setting the speaker distance

- FRNT D (front speaker distance),
- CNTR D (center speaker distance),
- SURR D (surround speaker distance),
- BACK D (surround back speaker distance)

The distance from your listening point to the speakers is another important element to obtain the best possible sound from the Surround and DSP modes. You need to set the distance from your listening point to the speakers. By referring to the speaker distance setting, this system automatically sets the delay time of the sound through each speaker so that sounds through all the speakers can reach you at the same time.

**Set the distance from the listening point to each speaker with the range of 0.3 m to 9.0 m (in 0.3 m intervals).**

**NOTE:**

If you have selected "NO" for "BACK SP" (see page 24), you cannot set the speaker distance for the surround back speaker.

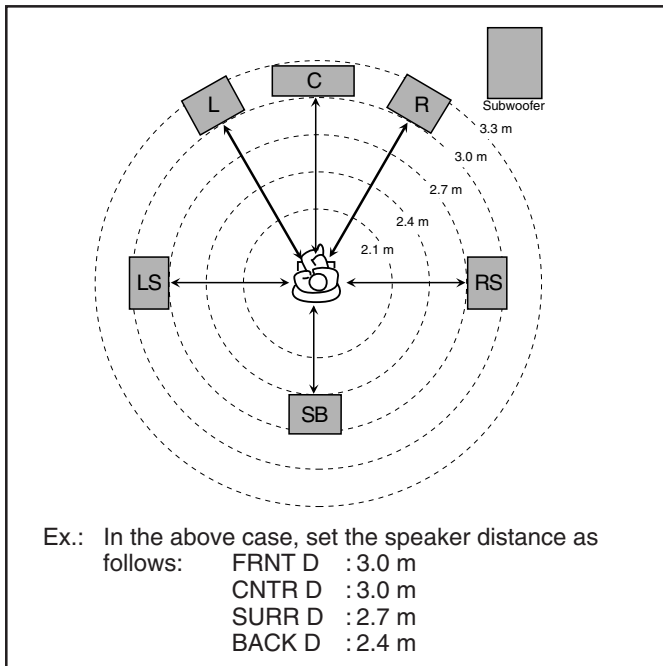

## Setting the crossover frequency—CROSS

Small speakers cannot reproduce the bass sounds efficiently. If you use a small speaker in any position, this system automatically reallocates the bass sound elements assigned to the small speaker to the large speakers.

To use this function properly, set the crossover frequency level according to the size of the small speaker connected.

- If you have selected "LARGE" for all speakers, this function does not take effect and you cannot change the frequency.

**Select one of the following settings:**

- 80Hz** :Select when the cone speaker unit built in the speaker is about 12 cm.
- 100Hz** :Select when the cone speaker unit built in the speaker is about 10 cm.
- 120Hz** :Select when the cone speaker unit built in the speaker is about 8 cm.
- 150Hz** :Select when the cone speaker unit built in the speaker is about 6 cm.
- 200Hz** :Select when the cone speaker unit built in the speaker is less than 5 cm.

**! CAUTION:**

When using the supplied speakers, select "200Hz."

**NOTE:**

Crossover frequency is not valid for the HEADPHONE mode.

## Setting the phase of subwoofer

—PHASE

Subwoofer phase is closely related with the distance from the listening position to the front speakers and subwoofer. You can change the phase to obtain better bass sound.

**Select one of the following settings:**

- NORMAL** :Normally select this.
- REVERS** :Select when you feel the bass sound is better with this mode rather than with "NORMAL."

## Setting the video output for DVD playback—M.OUT (monitor out)

After connecting your TV (see page 7), select the video output jack type you watch the DVD playback. Setting this properly, you can use AV COMPU LINK remote control system.—The TV automatically changes the video input mode to the appropriate position (see "AV COMPU LINK remote control system" on pages 60 and 61).

- "VIDEO" is initial setting.

**Select one of the following settings:**

- VIDEO** :Select when you watch the DVD playback through the VIDEO jack.
- S** :Select when you watch the DVD playback through the S-VIDEO jack.
- COMPNT** :Select when you watch the DVD playback through the COMPONENT VIDEO OUT jacks.



# Audio adjustments

You can adjust sound to your preference according your listening conditions or sources.

- You can also adjust sound using the choice menu except "AUDIO POS" and "B.BOOST" (see page 54).

## Operating procedure

Before you start, remember...

There is a time limit in doing the following steps. If the setting is canceled before you finish, start from step 1 again.

From the remote control ONLY:

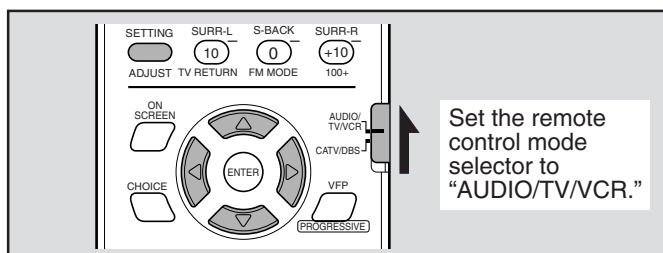

### 1 Press SETTING/ADJUST twice.

"ADJUST" appears on the display.

- Each time you press SETTING/ADJUST, the function for the button changes as follow.

**SETTING** → **ADJUST** → current source →  
(back to the beginning)

### 2 Press Cursor ▼/▲ repeatedly to select the item you want to adjust while "ADJUST" appears on the display.

- Each time you press the button, the item shown on the display changes as follow:

**BASS**      ⇄ **TREBLE**      ⇄ **LFE ATT.**      ⇄  
**MIDNIGHT** ⇄ **B.BOOST** ⇄ **AUDIO POS** ⇄  
**BAL**        ⇄ (back to the beginning)

### 3 Press Cursor ►/◀ repeatedly to select the appropriate setting for the item.

Your adjustment is stored.

## Adjusting the tone—BASS, TREBLE

You can adjust the bass and treble sounds as you like.

**Adjust the bass or treble level of the front channel signal in 2 step intervals.**

- Adjustable range: "–10" to "10."

## Setting the level of the low frequency effect attenuator—LFE ATT.

The Low Frequency Effect attenuator diminishes the distortion of the bass sound from the subwoofer when playing back Dolby Digital or DTS Digital Surround software.

**Turn ON or OFF the LFE attenuator:**

**ON (–10 dB)** :Select to diminish the distortion of the bass sound from the subwoofer.

**OFF (0 dB)** :Select to cancel this function.

## Setting the dynamic range

—MIDNIGHT

You can reinforce the bass sound if bass sounds are not sufficient.

**Select one of the following settings:**

**1** :Select when you want to reduce the dynamic range a little.

**2** :Select when you want to apply the compression effect fully (useful at night).

**OFF** :Select when you want to enjoy surround with its full dynamic range (no effect applied).

## Reinforcing the bass sound

—B (bass).BOOST

You can activate or deactivate the bass boost.

- When bass boost is turned on, the BASS indicator lights up on the display.

**Turn ON or OFF bass boost.**

**ON** :Select when activating bass boost.

**OFF** :Select when deactivating bass boost.

## Setting the subwoofer audio position—AUDIO POS (position)

You may feel subwoofer is reinforced when listening stereo sound.

If this is the case, you can automatically change the subwoofer level properly when listening stereo sound.

- To adjust the subwoofer level, see page 17.

**Select the automatic adjustment level from "0" to "–6" (in –2 step intervals):**

If no adjustment is required, select "0." The smaller the number becomes, the more the level decreases automatically when listening in stereo.

## Adjusting the front speakers balance—BAL (balance)

If the sounds through the front speakers are not well-balanced, adjust the front speaker output balance.

**Adjust the front speakers' output balance within the range of "R –21" to "L –21."**

- "R –21": no sound comes out of the right speaker.

- "L –21": no sound comes out of the left speaker.

- "CENTER": output levels of both speakers are identical.

# Creating realistic sound fields

This system activates a variety of Surround modes and DSP (Digital Signal Processor) modes. To use Surround or DSP modes properly, speakers required for creating each Surround and DSP mode should be activated.

## Surround modes

### ■ Reproducing theater ambience

In a movie theater, many speakers are located on the walls to reproduce impressive multi-surround sounds, reaching you from all directions.

With these many speakers, sound localization and sound movement can be expressed.

Surround modes built in this system can create almost the same surround sounds as you can feel in a real movie theater.

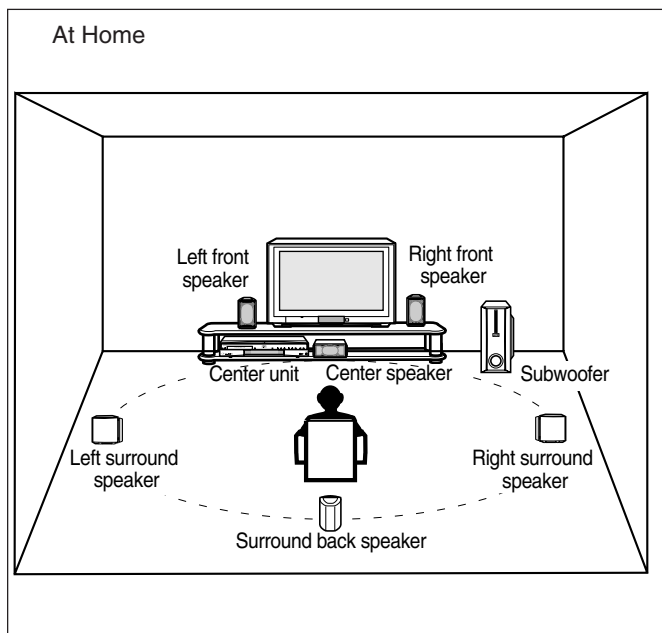
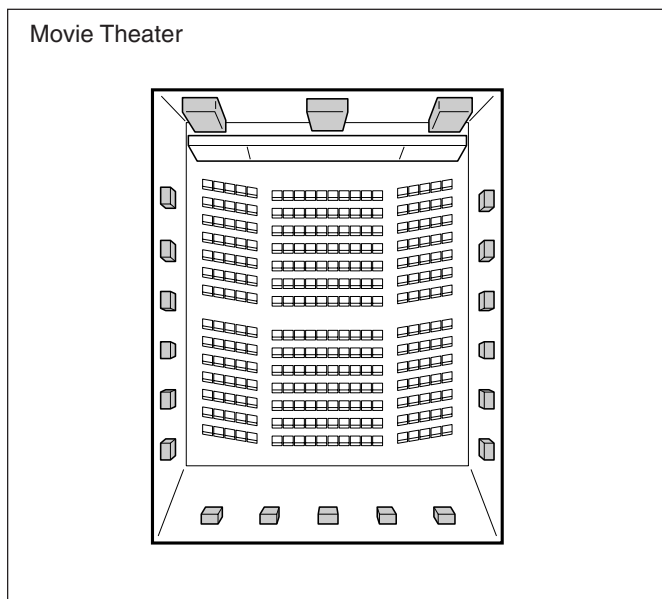

### ■ Introducing the Surround modes

#### Dolby Surround

#### **Dolby Digital EX\***

Best used to reproduce multi-channel movie soundtracks of the software encoded with Dolby Digital EX (  ).

**Dolby Digital EX** is a newly introduced surround encoding format as an extension of multi-channel Dolby Digital, designed to add an extra surround channel to Dolby Digital 5.1-channel (see below). By using a matrix encoding/decoding method, additional "surround back" channel signal is encoded (and decoded) in both the left and right surround channel signals.

Compared to the conventional Dolby Digital 5.1-channel, this newly added surround back channel can reproduce more detailed movements behind you while viewing the video software. In addition, surround sound localization will become more stable, so that you can enjoy a realistic surround field in your listening room.

- When Dolby Digital EX is activated, the  DIGITAL EX and SURROUND indicators light up on the display.

#### **Dolby Digital\***

Used to reproduce multi-channel soundtracks of the software encoded with Dolby Digital (  ).

**Dolby Digital 5.1-channel** encoding method (so-called discrete 5.1-channel digital audio format) records and digitally compresses the left front channel, right front channel, center channel, left surround channel, right surround channel, and LFE channel signals (total 6 channels, but LFE channel is counted as 0.1 channel, therefore, called 5.1-channel).

Since each channel is completely independent from the other channel signals to avoid interference, you can obtain a much better sound quality with better stereo and surround effects.

- When Dolby Digital is activated, the  DIGITAL and SURROUND indicators light up on the display.
- \* Dolby Digital software can be roughly grouped into two categories—multi-channel (up to 5.1-channel) and 2-channel software. To enjoy surround sound while playing Dolby Digital 2-channel software, you can use Dolby Pro Logic II.

#### NOTE: MPEG Multichannel

MPEG Multichannel signals are converted into Linear PCM signals, then reproduced.

# Creating realistic sound fields

## Dolby Pro Logic II\*

Dolby Pro Logic II has a newly developed multi-channel playback format to convert all 2-channel source including Dolby Surround into 5-channel (plus subwoofer) reproduction.

Matrix-based conversion method for Dolby Pro Logic II makes no limitation for the cutoff frequency of the surround treble and enables stereo surround sound unavailable with conventional Dolby Pro Logic.

Dolby Pro Logic II can reproduce spacious sound from original sound without adding any new sounds and tonal colorations.

Dolby Pro Logic II has two modes—**Movie mode** and **Music mode**.

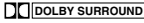
**Pro Logic II Movie (PL II MOVIE)**—suitable for the reproduction of Dolby Surround encoded software bearing the mark (  ). You can enjoy a sound field very close to the one created with discrete 5.1-channel sounds. **Pro Logic II Music (PL II MUSIC)**—suitable for the reproduction of any 2-channel stereo software. You can enjoy wide and deep sound by using this mode.

- When Dolby Pro Logic II is activated, the  PRO LOGIC II and SURROUND indicators light up on the display.

## Dolby Pro Logic (Dolby Surround)\*

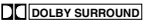
Used to reproduce soundtracks of the software encoded with Dolby Surround (  ).

**Dolby Surround** encoding format records the left front channel, right front channel, center channel, and surround channel signal (total 4 channels) into 2 channels.

The Dolby Pro Logic decoder built in this system decodes these 2-channel signal into original 4-channel signals—matrix-based multi-channel reproduction, and allows you to enjoy a realistic surround sound in your listening room.

- When Dolby Pro Logic is activated, the  PRO LOGIC and SURROUND indicators light up on the display.

\* *Manufactured under license from Dolby Laboratories. “Dolby,” “Pro Logic,” and the double-D symbol are trademarks of Dolby Laboratories.*

\*\* *Manufactured under license from Digital Theater Systems, Inc. US Pat. No. 5,451,942 and other world-wide patents issued and pending. “DTS” and “DTS Digital Surround” are trademarks of Digital Theater Systems, Inc. Copyright 1996 Digital Theater Systems, Inc. All rights reserved.*

## DTS Surround

### DTS-ES (Extended Surround)\*\*

Used to reproduce multi-channel movie soundtracks of the software encoded with DTS-ES (  ).

**DTS-ES** is another new digital surround encoding format, developed by Digital Theater Systems, Inc., that adds the third surround channel—surround back channel. (See “Dolby Digital EX” on page 27)

DTS ES has two types—**DTS-ES Discrete 6.1-channel** and **DTS-ES Matrix 6.1-channel**.

**DTS-ES Discrete 6.1-channel**—has been designed to encode (and decode) 6.1-channel signal discretely to avoid interference between each channel.

**DTS-ES Matrix 6.1-channel**—has been designed to add an extra surround channel to DTS Digital Surround 5.1-channel. By using a matrix encoding/decoding method, additional “surround back” channel signal is encoded (and decoded) in both the left and right surround channel signals.

- When DTS-ES is activated, the  and SURROUND indicators light up on the display.

### DTS Digital Surround\*\*

Used to reproduce multi-channel soundtracks of the software encoded with DTS Digital Surround (  ).

DTS Digital Surround is a discrete 5.1-channel digital audio format available on CD, LD, and DVD software.

Compared to Dolby Digital, DTS Digital Surround format has a lower audio compression ratio which enables it to add breadth and depth to the sounds reproduced. As such, DTS Digital Surround features natural, solid and clear sound.

- When DTS Digital Surround is activated, the  and SURROUND indicators light up on the display.

### NEO:6\*\*

**Neo:6** is a newly developed conversion method to create 6-channel (plus subwoofer) from analog/digital 2-channel source and DTS Digital Surround source.

Neo:6 has two modes—**Neo:6 Cinema** and **Neo:6 Music**:

**Neo:6 Cinema**—suitable for reproduction of surround encoded software.

**Neo:6 Music**—suitable for reproduction of music software.

- When NEO:6 is activated, the SURROUND indicator lights up on the display.
- DTS Digital Surround can be converted into 6.1-channel using NEO:6 (see page 24).

## Playback software and reproduced channels for each Surround mode

Surround mode	Dolby Digital EX	Dolby Digital 5.1-channel	Dolby Pro Logic II	Dolby Pro Logic
Playback software	Dolby Digital EX	Dolby Digital 5.1-channel Dolby Digital EX	2-channel software	Dolby Surround 2-channel stereo software
Reproduced channels	6.1 channels	5.1 channels	5 channels (+ subwoofer)	4 channels (+ subwoofer)

Surround mode	DTS-ES Discrete 6.1-channel	DTS-ES Matrix 6.1-channel	DTS Digital Surround	Neo6: Cinema/ Neo6: Music
Playback software	DTS-ES (with Discrete 6.1-channel signals)	DTS-ES (with Matrix 6.1-channel signals)	DTS Digital Surround DTS-ES	2-channel software DTS Digital Surround
Reproduced channels	6.1 channels	6.1 channels	5.1 channels	6 channels (+ subwoofer)



## DSP modes

### DAP (Digital Acoustic Processor) modes

The sound heard in a concert hall, club, etc. consists of direct sound and indirect sound—early reflections and reflections from behind. Direct sounds reach the listener directly without any reflection. On the other hand, indirect sounds are delayed by the distances of the ceiling and walls (see the diagram below). These direct and indirect sounds are the most important elements of the acoustic surround effects.

The DAP mode can reproduce a realistic sound field by adding these indirect sounds.

- When one of the DAP modes is selected, the DSP indicator lights up on the display.

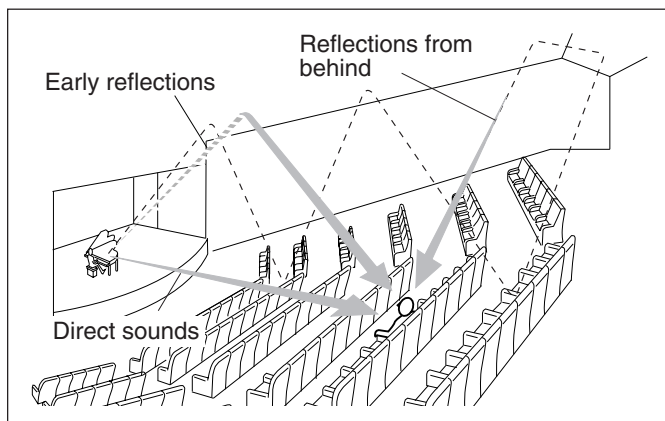

You can use the following DAP modes in order to reproduce a more acoustic sound field in your listening room.

<b>THEATER</b>	:Reproduces the sound field of a theater .
<b>HALL</b>	:Gives clear vocal and the feeling of a large concert hall.
<b>LIVE CLUB</b>	:Gives the feeling of a live music club with a low ceiling.
<b>DANCE CLUB</b>	:Gives a throbbing bass beat.
<b>PAVILION</b>	:Gives the spacious feeling of a pavilion with a high ceiling.

### All Channel Stereo

All Channel Stereo (ALL CH ST.) can reproduce a larger stereo sound field using all the connected (and activated) speakers.

All Channel Stereo can be used when the front and surround speakers are connected to the center unit.

- When All Channel Stereo is selected, the DSP indicator lights up on the display.

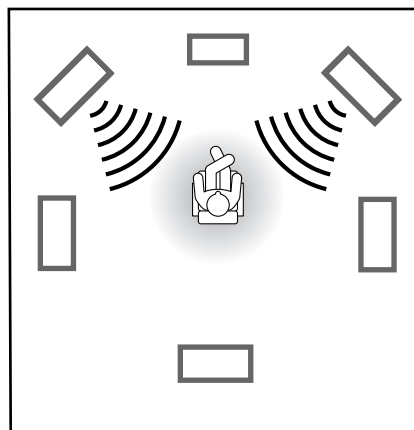

Conventional stereo

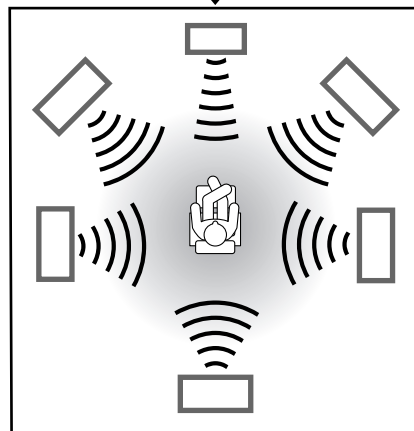

All Channel Stereo

# Creating realistic sound fields

## Speaker and signal indicators

According to the incoming signal, speaker and signal indicators light up as follow.

Playing source	Available Surround or DSP mode	Indicators
Dolby Digital EX 6.1-channel	DOLBY D EX	
Dolby Digital EX 6.1-channel	DOLBY D*	
Dolby Digital EX 6.1-channel	DAP modes ALL CH ST.	
Dolby Digital EX 6.1-channel	OFF	
Dolby Digital 5.1-channel	DOLBY D EX**	
Dolby Digital 5.1-channel	DOLBY D	
Dolby Digital 5.1-channel	DAP modes ALL CH ST.	
Dolby Digital 5.1-channel	OFF	
Dolby Digital 2-channel	PLII MOVIE PLII MUSIC	
Dolby Digital 2-channel	PRO LOGIC	
Dolby Digital 2-channel	NEO6: CINEMA NEO6: MUSIC	
Dolby Digital 2-channel	DAP modes*** ALL CH ST.	
Dolby Digital 2-channel	OFF	
DTS-ES Discrete 6.1-channel	DTS-ES DSCRT	
DTS-ES Matrix 6.1-channel	DTS-ES MATRX	
DTS-ES Discrete/Matrix 6.1-channel	DTS*	
DTS-ES Discrete/Matrix 6.1-channel	DAP modes ALL CH ST.	
DTS-ES Discrete/Matrix 6.1-channel	OFF	
DTS 5.1-channel	DTS + NEO:6**	
DTS 5.1-channel	DTS	
DTS 5.1-channel	DAP modes ALL CH ST.	
DTS 5.1-channel	OFF	

Playing source	Available Surround or DSP mode	Indicators
DTS 2-channel	NEO6: CINEMA NEO6: MUSIC	
DTS 2-channel	PLII MOVIE PLII MUSIC	
DTS 2-channel	PRO LOGIC	
DTS 2-channel	DAP modes*** ALL CH ST.	
DTS 2-channel	OFF	
Linear PCM	PLII MOVIE PLII MUSIC	
Linear PCM	PRO LOGIC	
Linear PCM	NEO6: CINEMA NEO6: MUSIC	
Linear PCM	DAP modes*** ALL CH ST.	
Linear PCM	OFF	
Analog	PLII MOVIE PLII MUSIC	
Analog	PRO LOGIC	
Analog	NEO6: CINEMA NEO6: MUSIC	
Analog	DAP modes*** ALL CH ST.	
Analog	OFF	

### About the indicators:

- L :Lights up when the left front signal comes in.
  - C :Lights up when the center signal comes in.
  - R :Lights up when the right front signal comes in.
  - LFE :Lights up when the LFE signal comes in.
  - S.WFR :Always lights up.
  - LS :Lights up when the left surround signal comes in.
  - RS :Lights up when the right surround signal comes in.
  - SB :Lights up when the surround back signal comes in.
  - S :Lights up when the surround signal (mono) comes in.
- Currently used speakers to output sound are shown by “ — ”.

### NOTES:

- \* These Surround modes are activated when “EX/ES” setting to “OFF” (see page 24).
- \*\* These Surround modes are activated when “EX/ES” setting to “ON” (see page 24).
- \*\*\* When selecting “THEATER,” the PRO LOGIC II indicator also lights up on the display.
- When “NO” is selected for the surround back speaker (see page 24), no sound outputs from the surround back speaker and the speaker indicator (“ — ”) for the surround back speaker does not light up.

## Using Surround mode

The system is so set up in its initial state that it automatically selects the optimal surround mode for each input signal — auto surround mode.

Only when you want to change a surround mode selected automatically, perform the following procedure.

- After having changed the surround mode, turning off the power or changing sources resumes the auto surround mode.

**From the remote control ONLY:**

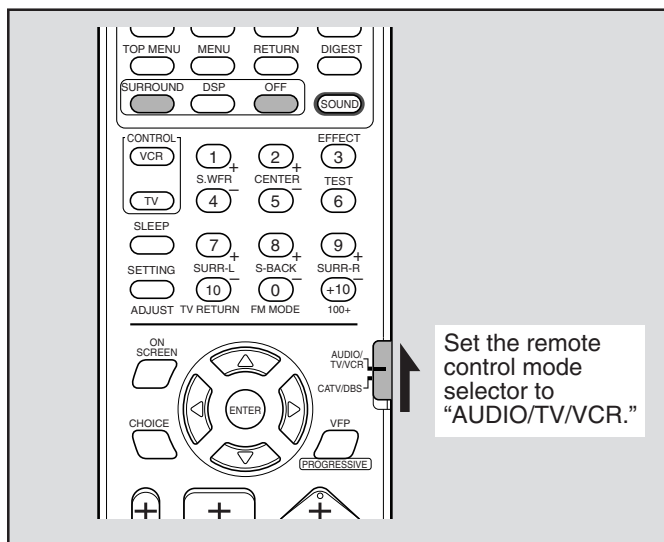

### 1 Start playing back software.

When playing back a components connected to VCR IN or DBS IN jacks, change the source to VCR or DBS.

- When you select a DBS tuner as the source to play, select the appropriate input mode (see page 18).

### 2 Press SURROUND.

- When playing back multi-channel digital software, an appropriate Surround mode will be selected according to your setting. See “Selecting the channel number to reproduce multi-channel digital software” on page 24 for details.
- If you are playing back any other software—analogue, Linear PCM, Dolby Digital 2-channel—the last selected Surround mode is activated. Each time you press the button, Surround mode changes as follows:

PL II MOVIE	⇒	PL II MUSIC	⇒
PRO LOGIC	⇒	NEO:6 CINEMA	⇒
NEO:6 MUSIC	⇒	(back to the beginning)	

- When Surround mode is activated, the SURROUND indicator lights up on the display.

### 3 If you want to add audio adjustment, see “Adjusting sound” on page 32.

### To cancel the Surround mode

Press OFF. The Surround mode is deactivated and the SURROUND indicator goes off from the display.

- If Surround mode is canceled while playing back multi-channel digital software, all channel signals are mixed and output through the front speakers.

## Using DSP mode

The DSP mode you have selected is stored for each source.

**From the remote control ONLY:**

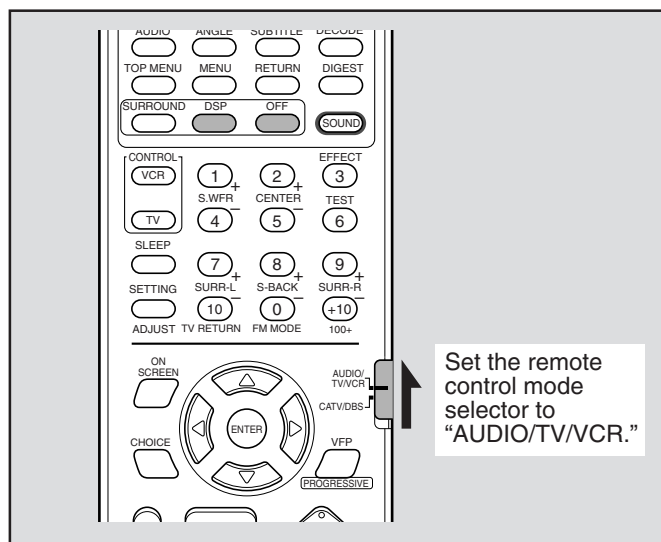

### 1 Start playing back software.

When playing back a components connected to VCR IN or DBS IN jacks, change the source to VCR or DBS.

- When you select a DBS tuner as the source to play, select the appropriate input mode (see page 18).

### 2 Press DSP.

The previously selected DSP mode is activated and the DSP indicator lights up on the display.

- Each time you press the button, DSP mode changes as follows:

THEATER	⇒	HALL	⇒	LIVE CLUB	⇒
DANCE CLUB	⇒	PAVILION	⇒	ALL CH ST.	⇒
(back to the beginning)					

### 3 If you want to add audio adjustment, see “Adjusting sound” on page 32.

### To cancel the DSP mode

Press OFF. The DSP mode is deactivated and the DSP indicator goes off from the display.

# Creating realistic sound fields

## Adjusting sound

Once you have adjusted the sound, the adjustment is stored for each source.

- You can also adjust the sound using the choice menu except the DSP effect level (see page 55).

*Before you start, remember...*

*There is a time limit in doing the following steps. If the setting is canceled before you finish, start from step 2 again.*

From the remote control ONLY:

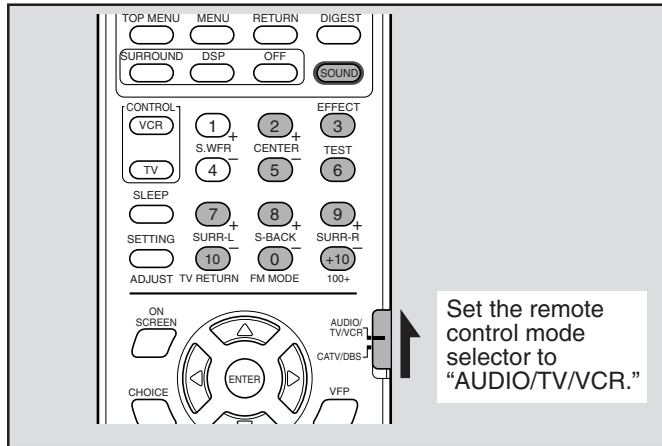

### 1 Press SOUND.

The 10 keys are activated for sound adjustments.

### 2 Press TEST to check if you can hear the sounds through the speakers at the equal level.

“TEST TONE L” and the corresponding signal indicator starts flashing on the display, and the test tone comes out of the speakers in the following order:

- You can adjust the speaker output levels without outputting the test tone.

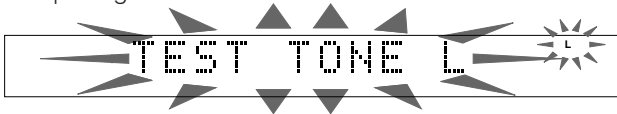

Left front speaker (L)	⇒
Center speaker (C)	⇒
Right front speaker (R)	⇒
Right surround speaker (RS)	⇒
Surround back speaker (SB)	⇒
Left surround speaker (LS)	⇒
(back to the beginning)	

### 3 Adjust the speaker output levels (−10 dB to +10 dB).

Adjust the center speaker, right and left surround speakers, and surround back speaker levels by comparing to the sound from the front speakers.

- To adjust the center speaker level, press CENTER +/-.
- To adjust the right surround speaker level, press SURR-R +/-.
- To adjust the surround back speaker level, press S-BACK +/-.
- To adjust the left surround speaker level, press SURR-L +/-.

### 4 Press TEST again to stop the test tone.

### 5 For DAP modes only:

Press EFFECT to select the effect level (1 to 5).

Each time you press the button, the effect level changes as follows:

DSP EFFECT 1 ⇔ DSP EFFECT 2 ⇔ DSP EFFECT 3 ⇔  
 DSP EFFECT 4 ⇔ DSP EFFECT 5 ⇔  
 (back to the beginning)

As the number increases, the selected mode becomes stronger (normally, set it to “DSP EFFECT 3”).

### After adjusting sound

Press DVD, FM/AM or VCR/TV CONTROL you selected as the source before sound adjustment.

- You can operate your target source again.

### NOTES:

- When “NO” is selected for the surround back speaker (see page 24), the test tone does not come out of the surround back speaker and you cannot adjust the surround back speaker's output level.
- The test tone for the subwoofer does not output. To adjust the subwoofer output level, see page 17.

# DVD player operations

This section explains advanced operations of the built-in DVD player **using the remote control**. For MP3 playback, see pages 46 and 47, and for JPEG playback, see pages 48 and 49.

- **Before using the remote control, press DVD to change the remote control operation mode.**
- Turn on your TV and select the correct input mode on the TV.
- See also “Basic DVD player operations” on page 20.
-  shows which types of disc are supported for the operations explained in each section. Unavailable disc types are shown in half-tone color.

⚠ If “⊘” appears on the TV when you press a button, the disc cannot accept an operation you have tried to do, or data required for that operation is not recorded on the disc.

## Using the on-screen bar

You can check the information on a disc while the disc is loaded, and you can use some functions through the on-screen bar.

### Showing the on-screen bar



From the remote control **ONLY**:

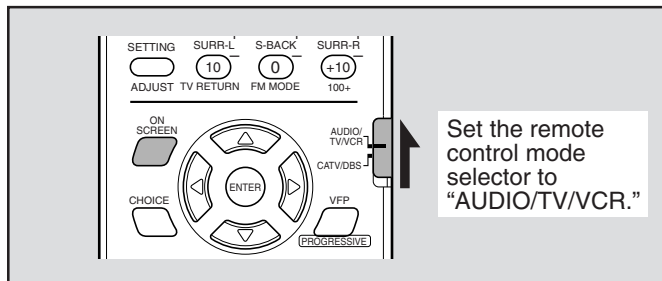

■ Whenever a disc is loaded

Press **ON SCREEN**.

- Each time you press the button, the on-screen bar changes as shown to the right.

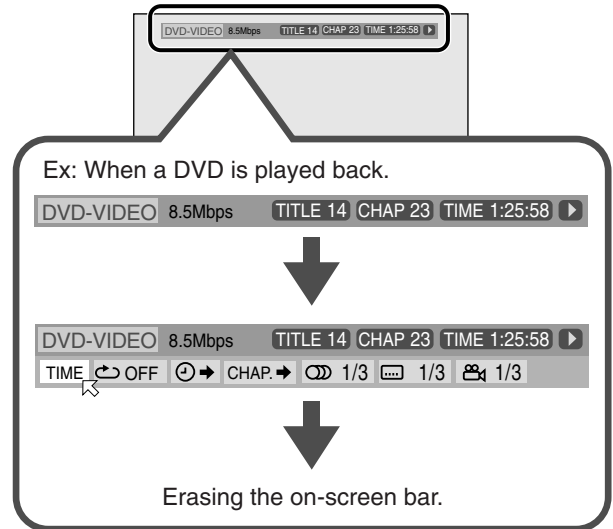

### Contents of the on-screen bar

Ex: When a DVD is played back.

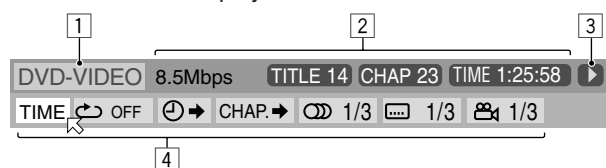

1 Disc type

2 Playback information

Mark	Shows:	Used for:
Mbps	Transfer rate (Megabits per second)	
TITLE 14	Title number	
CHAP 23	Chapter number	
TRACK 14	Track number	
TOTAL 1:25:58	Elapsed playing time	

3 Playback conditions for all types of disc

Mark	Shows a currently loaded disc:
	Plays back
	Fast-forwards/fast-reverses
	Plays back in slow motion (forward/reverse)
	Pauses
	Stops

4 Optional icons

Mark	Select to:	Available for:	See also page
	Change the time information		34
	Play repeatedly		45
	Use time search		39
	Use chapter search		39
Ex.	Change the audio language/channel		37 38
Ex.	Change subtitle language		37
Ex.	Change the view angle		36
	Use program play		44
	Play randomly		44

# DVD player operations

## Basic operation through the on-screen bar



See the corresponding pages for details of each function.

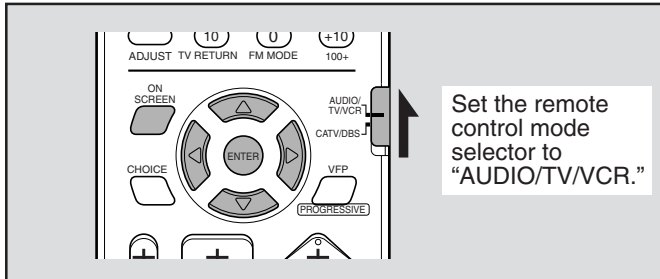

### ■ When a disc is loaded

Ex.: To select "TITLE" for the repeat mode during DVD play:

#### 1 Press ON SCREEN twice.

The following on-screen bar appears on the TV.



#### 2 Press Cursor >/< repeatedly to move to TIME .



#### 3 Press ENTER.

The pop-up window appears under the on-screen bar.



- The previously selected option appears.

#### 4 Press Cursor >/< repeatedly to select the desired option.

- Each time you press the button, the options change.



#### 5 Press ENTER.

The setting changes and the pop-up window goes off.



### To erase the on-screen bar

Press ON SCREEN.

## Changing the time information



You can change the time information in the on-screen bar and the display on the center unit.

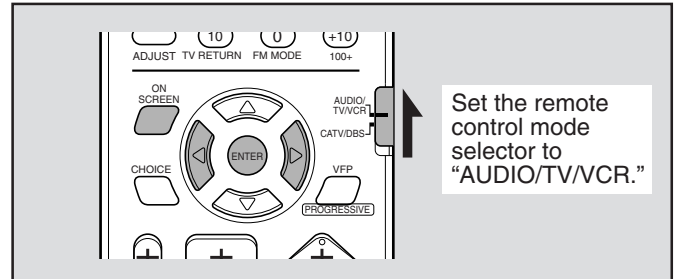

### ■ During playback or while stopped

#### 1 Press ON SCREEN twice.

The on-screen bar appears on the TV.

#### 2 Press Cursor >/< repeatedly to move to TIME .

#### 3 Press ENTER.

- Each time you press the button, the time information changes as follows.

Ex.: When playing back a DVD:

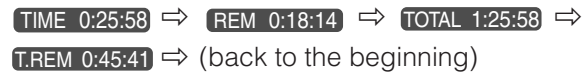

**TIME** :Elapsed playing time of the current chapter/track

**REM** :Remaining time of the current chapter/track

**TOTAL** :Elapsed time of the disc

**T.REM** :Remaining time of the disc

### To erase the on-screen bar

Press ON SCREEN.



**NOTE:** For a VCD, SVCD, or Audio CD, the hour digit is not displayed.



## Locating a particular scene from the disc menu



Using the disc menu, you can start playing a title, chapter, or track you specify.

### Locating a particular scene from the DVD menu

DVD discs generally have their own menus which show the disc contents. These menus contain various items such as titles of movies, names of songs, or artist information, and display them on the TV screen. You can locate a desired scene by using these menus.

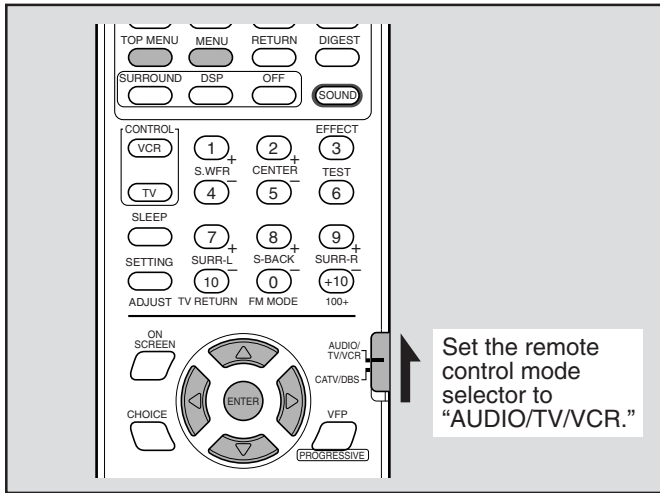

#### ■ When a DVD is loaded

##### 1 Press TOP MENU or MENU.

The DVD menu appears on the TV. (The menu usually appears on the TV automatically after loading DVD VIDEO.)

Ex.:

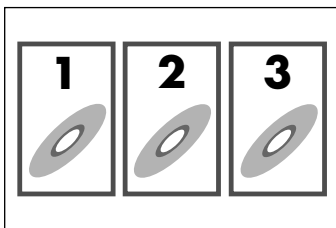

DVD normally has a "title" menu when it contains more than one title. In this case, press TOP MENU to show the title menu.

Some DVD may also have a different menu which is shown by pressing the MENU button. See the instructions of each DVD for its particular menu.

##### 2 Use Cursor $\blacktriangleright$ / $\blacktriangleleft$ / $\blacktriangledown$ / $\blacktriangleup$ to select a desired item, then press ENTER.

The system starts playback from the selected item.

- With some discs, you can also select items by entering the corresponding number using the number buttons.

## Locating a particular scene from the VCD/SVCD menu with PBC

VCD or SVCD recorded with PBC has its own menus such as a list of the tracks. (After loading such a disc, "PBC" appears on the display.) You can locate the specific track by using the menu (see also page 6).

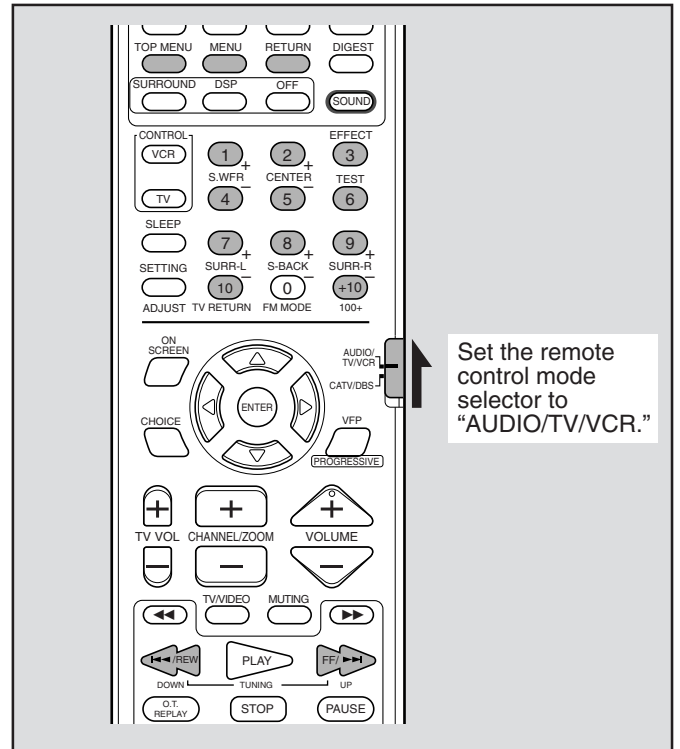

#### ■ When a menu appears on the TV while playing a VCD/SVCD with PBC

Press the number buttons (1–10, +10) to select the number of the desired item.

The system starts playback from the selected item.

Ex.: To select 3, press 3.

To select 11, press +10, then 1.

##### To return to the menu

Press RETURN.

##### When "NEXT" or "PREVIOUS" is shown on the TV screen:

- To go to the next page, press FF/ $\blacktriangleright$ .
- To return to the previous page, press  $\blacktriangleleft$ /REW.

##### To play back a PBC-compatible VCD/SVCD deactivating PBC

Start playback by pressing the number buttons.

The elapsed playing time appears on the display instead of "PBC."

##### To activate PBC again

Press TOP MENU or MENU.

"PBC" appears again on the display.

# DVD player operations

## Selecting a view angle



While playing back a DVD containing multi-view angles, you can enjoy the same scene at different angles.

- The icon appears at the beginning of the playback when the current scene has multi-view angles.

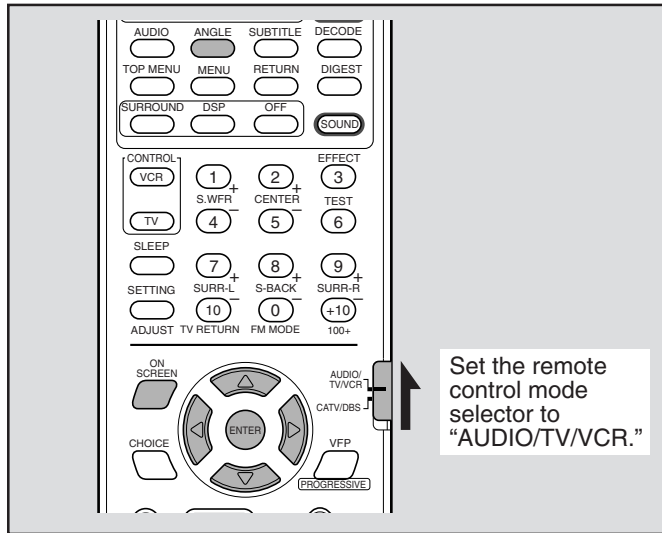

Using the on-screen bar:

- 1 Press ON SCREEN twice.

The on-screen bar appears on the TV.

- 2 Press Cursor / repeatedly to move to 1/3, then press ENTER.

The pop-up window appears under the on-screen bar.



Ex.: The first view angle is selected out of 3 view angles recorded.

- 3 Press Cursor / repeatedly to select the desired view angle.

- Each time you press the button, the angle of the scene changes.

- 4 Press ENTER.

The pop-up window goes off.

**To erase the on-screen bar**

Press ON SCREEN.

## Selecting a view angle

■ During playback

- 1 Press ANGLE.

The pop-up window appears on the TV.

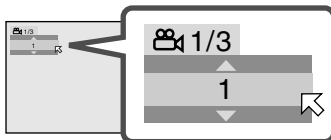

Ex.: The first view angle is selected out of 3 view angles recorded.

- 2 Press ANGLE or Cursor / repeatedly to select the desired view angle.

- Each time you press the button, the angle of the scene changes.

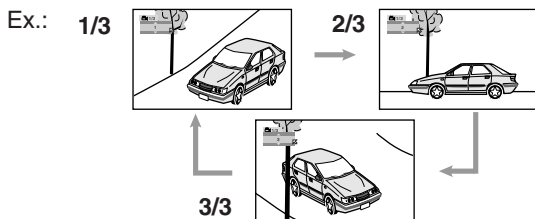

- The pop-up window goes off if no operation is done for about 5 seconds.

## Showing all view angles on the TV

■ During playback

- 1 Press and hold ANGLE for more than 1 second.

Up to 9 pictures of the different view angles recorded on the disc appear on the TV screen.

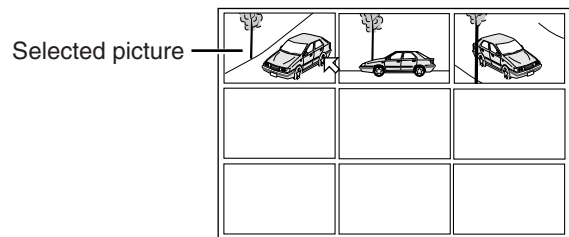

Ex.: When 3 view angles are recorded.

- 2 Press Cursor / / / repeatedly to move to the desired view.

- 3 Press ENTER.

The angle list goes off, and playback starts at the selected view angle.



**NOTE:** While the angle list is shown on the TV, no sound comes out.



# Changing the subtitle and audio languages

## Selecting the subtitle language



While playing back a DVD (or SVCD) containing the subtitles in different languages, you can select the subtitle language to be displayed on the TV.

- The icon appears at the beginning of the playback when the current scene has several subtitles.
- You can set your favorite language as the initial language (see page 52).

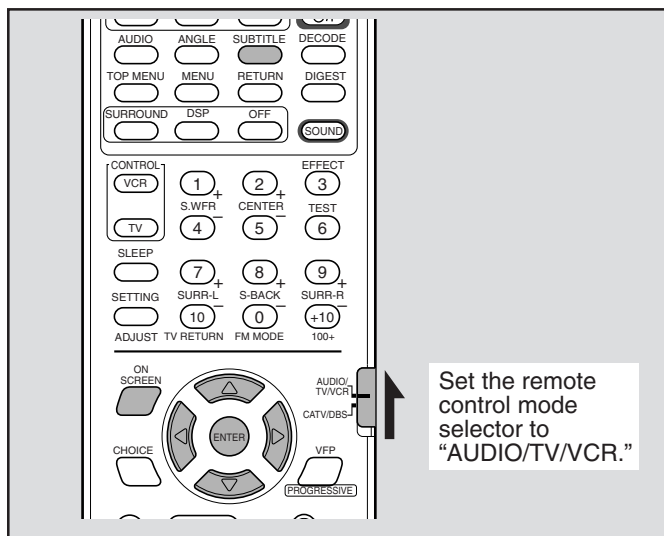

### ■ During playback

#### 1 Press SUBTITLE.

The pop-up window appears on the TV.

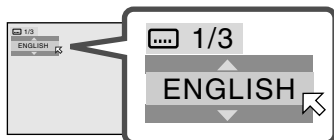

Ex.: "ENGLISH" is selected out of 3 subtitle languages recorded.

#### 2 Press SUBTITLE or Cursor $\blacktriangledown/\blacktriangle$ repeatedly to select the desired subtitle language.

Each time you press the button, the subtitle languages change.

- The pop-up window goes off if no operation is done for about 5 seconds.

### Using the on-screen bar:

#### 1 Press ON SCREEN twice.

The on-screen bar appears on the TV.

#### 2 Press Cursor $\blacktriangleright/\blacktriangleleft$ repeatedly to move to , then press ENTER.

The pop-up window appears under the on-screen bar.



Ex.: "ENGLISH" is selected out of 3 subtitle languages recorded.

#### 3 Press Cursor $\blacktriangledown/\blacktriangle$ repeatedly to select the desired subtitle language.

Each time you press the button, the subtitle languages change.

#### 4 Press ENTER.

The pop-up window goes off.

### To erase the on-screen bar

Press ON SCREEN.

### NOTES:

- For DVD: Some subtitle languages are shown by their abbreviation. See "Language codes list" on page 52.
- For SVCD: Up to four subtitles can be selected. Pressing SUBTITLE changes the subtitles whether the subtitles are recorded or not.

## Selecting the audio language



When a DVD contains audio languages (soundtrack), you can select the language (soundtrack) to listen to.

- The icon appears at the beginning of the playback when the current scene has several audio languages.
- You can set your favorite language as the initial language (see page 52).

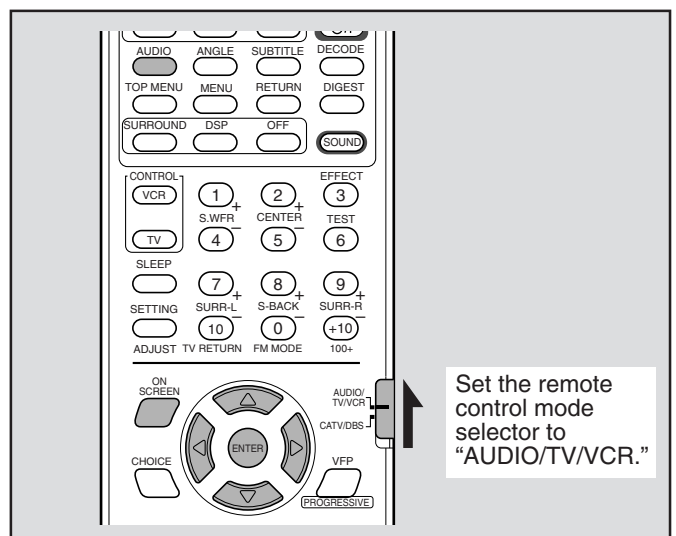

### ■ During playback

#### 1 Press AUDIO.

The pop-up window appears on the TV.

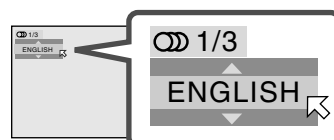

Ex.: "ENGLISH" is selected out of 3 audio languages recorded.

# DVD player operations

## 2 Press AUDIO or Cursor ▼/▲ repeatedly to select the desired audio language.

Each time you press the button, the audio languages change.

- The pop-up window goes off if no operation is done for about 5 seconds.

### Using the on-screen bar:

#### 1 Press ON SCREEN twice.

The on-screen bar appears on the TV.

#### 2 Press Cursor ►/◄ repeatedly to move to , then press ENTER.

The pop-up window appears under the on-screen bar.



Ex.: "ENGLISH" is selected out of 3 audio languages recorded.

#### 3 Press Cursor ▼/▲ repeatedly to select the desired audio language.

Each time you press the button, the audio languages change.

#### 4 Press ENTER.

The pop-up window goes off.

#### To erase the on-screen bar

Press ON SCREEN.



#### NOTE:

For DVD: Some audio languages are shown by its abbreviation. See "Language codes list" on page 52.

## Selecting the audio channel



When you play some Karaoke VCDs or SVCDs, you can enjoy karaoke by selecting the audio channel to play.

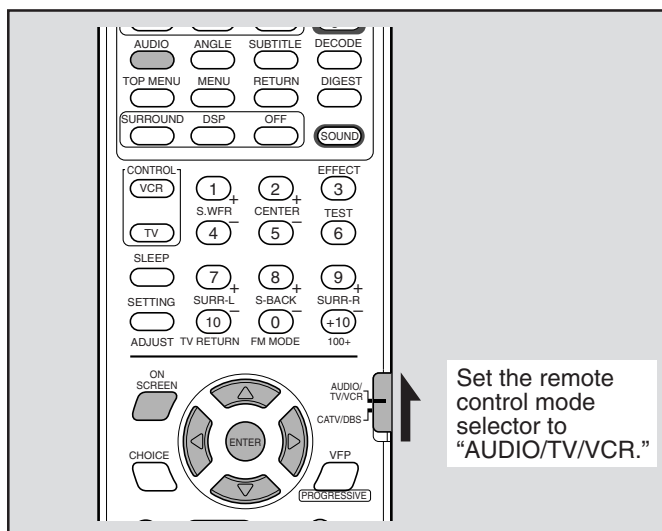

### ■ During playback

#### 1 Press AUDIO.

The pop-up window appears on the TV.

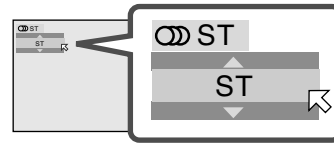

Ex.: A VCD is played back.

#### 2 Press AUDIO or Cursor ▼/▲ repeatedly to select the desired audio channel.

Each time you press the button, the audio channels change.

- The pop-up window goes off if no operation is done for about 5 seconds.

#### For VCD:

ST ⇒ L ⇒ R ⇒ (back to the beginning)

**ST** : To listen to normal stereo playback.

**L** : To listen to the L (left) audio channel.

**R** : To listen to the R (right) audio channel.

#### For SVCD:

ST 1 ⇒ ST 2 ⇒ L 1 ⇒ R 1 ⇒ L 2 ⇒ R 2 ⇒  
(back to the beginning)

**ST 1** : To listen to normal stereo playback of ST 1.

**ST 2** : To listen to normal stereo playback of ST 2.

**L 1** : To listen to the L (left) channel of ST 1.

**R 1** : To listen to the R (right) channel of ST 1.

**L 2** : To listen to the L (left) channel of ST 2.

**R 2** : To listen to the R (right) channel of ST2.

### Using the on-screen bar:

#### 1 Press ON SCREEN twice.

The on-screen bar appears on the TV.

#### 2 Press Cursor ►/◄ repeatedly to move to , then press ENTER.

The pop-up window appears under the on-screen bar.

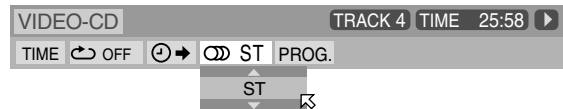

Ex.: A VCD is played back.

#### 3 Press Cursor ▼/▲ repeatedly to select the desired audio channel.

Each time you press the button, the audio channel changes.

#### 4 Press ENTER.

The pop-up window goes off.

#### To erase the on-screen bar

Press ON SCREEN.

## Playing from a particular position

You can start playing a title, chapter, or track you specify. You can also play a disc from the specified time.

### Locating a particular chapter —Chapter search



When playing back a DVD disc, you can locate the chapter number to be played.

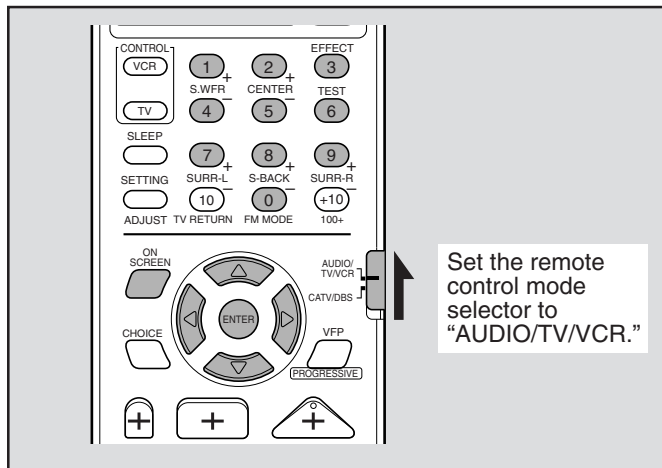

#### ■ During playback

### 1 Press ON SCREEN twice.

The on-screen bar appears on the TV.

### 2 Press Cursor $\blacktriangleright/\blacktriangleleft$ repeatedly to move to **CHAP. $\rightarrow$** , then press ENTER.

The pop-up window appears under the on-screen bar.

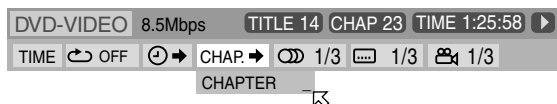

### 3 Press the number buttons (0–9) to enter the desired chapter number.

Ex.:

To select chapter number 8, press 8.

To select chapter number 10, press 1 then 0.

To select chapter number 37, press 3 then 7.

#### To correct a mis-entry

Repeat step 3 until the correct number appears in the pop-up window.

### 4 Press ENTER.

The system starts playback from the selected chapter.

#### To erase the on-screen bar

Press ON SCREEN.

#### NOTES:

- You can also use the 10 button to enter “10.”
- The +10 button is not used in this function.
- You can select up to chapter number 99.

## Locating a particular position —Time search



You can start playing at your desired position by specifying the elapsed playing time from the beginning of the current title (for DVD), or from the beginning of the disc (for VCD/SVCD/Audio CD).

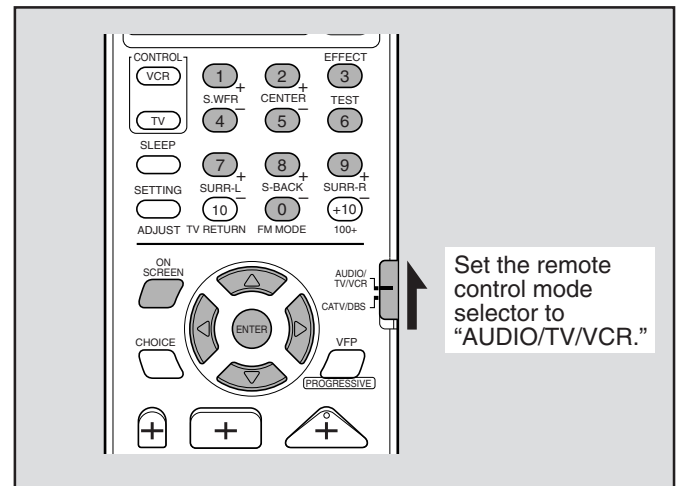

- For DVD :During playback
- For VCD/SVCD :During playback without activating PBC or while stopped
- For Audio CD :During playback or while stopped

### 1 Press ON SCREEN twice.

The on-screen bar appears on the TV.

### 2 Press Cursor $\blacktriangleright/\blacktriangleleft$ repeatedly to move to **TIME $\rightarrow$** , then press ENTER.

The pop-up window appears under the on-screen bar.

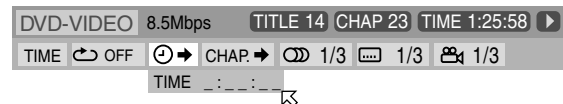

### 3 Press the number buttons (0–9) to enter the specified time.

Ex.:

To play back from a point of 2 (hours): 34 (minutes): 08 (seconds) elapsed from the beginning:

Press 2, 3, 4, 0, then 8.

#### To correct a mis-entry

Press Cursor  $\blacktriangleleft$  repeatedly until the wrong number is erased, then press the number buttons to enter the correct number.

### 4 Press ENTER.

The system starts playback from the specified time.

#### To erase the on-screen bar

Press ON SCREEN.

#### NOTES:

- You can also use the 10 button to enter “10.”
- The +10 button is not used in this function.
- You can specify the time in hours/minutes/seconds for DVD, and in minutes/seconds for VCD/SVCD/Audio CD.

# DVD player operations

## Locating a particular scene —DIGEST



The system can display the opening scene of each title or chapter on a DVD or each track of a VCD/SVCD. You can select a desired one from the opening scenes shown on the TV screen.

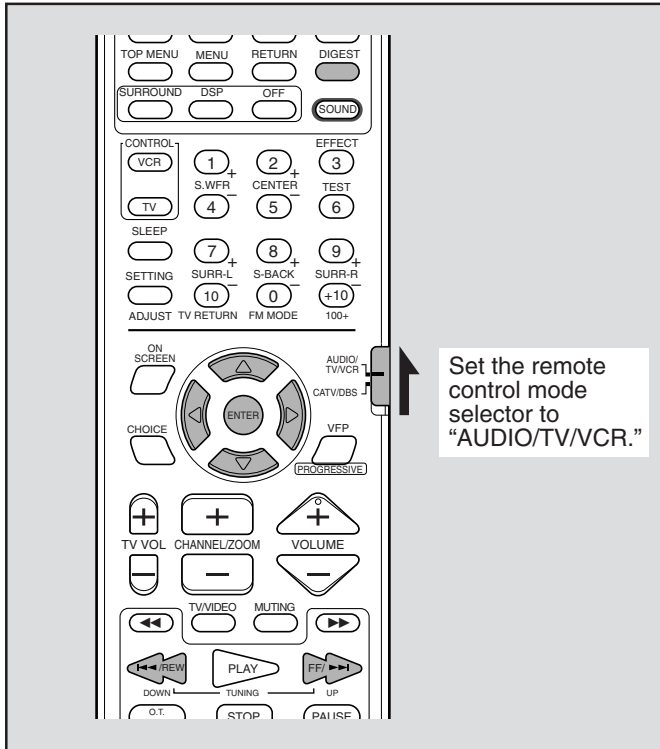

- For DVD :During playback or while stopped
- For VCD/SVCD :During playback without activating PBC or while stopped

### 1 Press DIGEST.

Up to 9 opening scenes are displayed.

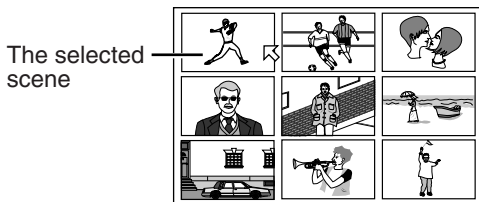

- **While a DVD is stopped:**  
The opening scene of each title appears on the TV screen .
- **During DVD playback:**  
The opening scene of each chapter contained in the current title appears on the TV screen.
- **When a VCD or SVCD is loaded:**  
The opening scene of each track appears on the TV screen.

### 2 Press Cursor $\blacktriangleright/\blacktriangleleft/\blacktriangledown/\blacktriangleup$ to move $\boxtimes$ to the desired scene.

- If there are more than 9 scenes, you can go to next page (see "To show other pages of the digest screen" below).

### 3 Press ENTER.

The system starts playback from the selected scene.

#### To show other pages of the digest screen

Press FF/ $\blacktriangleright$ , to show the next page.

Press  $\blacktriangleleft$ /REW to show the previous page.

or

To show the previous page, press Cursor  $\blacktriangleright/\blacktriangleleft/\blacktriangledown/\blacktriangleup$  to select the left top scene, then press Cursor  $\blacktriangleleft$ .

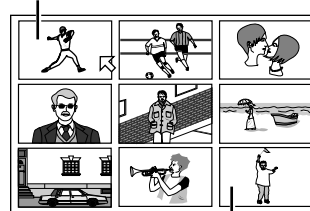

To show the next page, press Cursor  $\blacktriangleright/\blacktriangleleft/\blacktriangledown/\blacktriangleup$  to select the right bottom scene, then press Cursor  $\blacktriangleright$ .



**NOTE:**  
For some discs, depending on the contents, it may take a time before all the scenes appear on the TV screen.

## Special picture playback

You can use special picture playback functions including frame-by-frame, strobe, slow-motion and zoom.

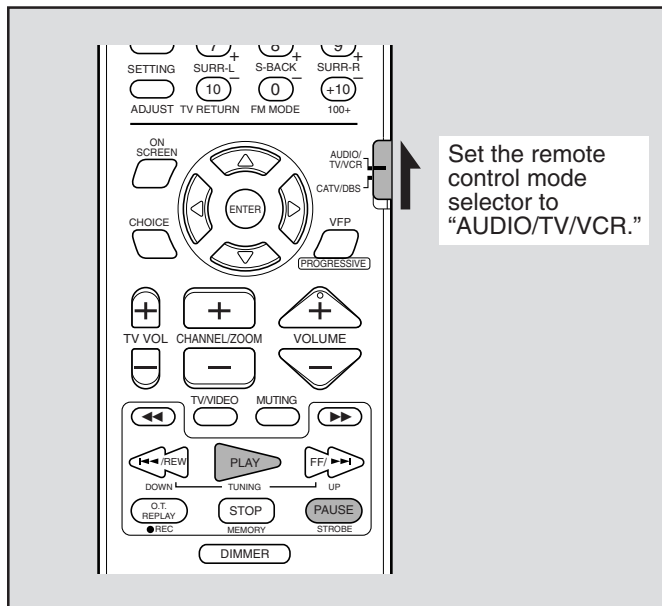

## Showing continuous still pictures



### ■ During playback

- 1 Press **STROBE** at the point you want to view as continuous pictures.

Playback pauses.

- 2 Press and hold **STROBE** for more than 1 second.

The same 9 frames (still pictures) appear on the TV screen.

- 3 Press **STROBE** once.

The picture in the middle on the top row shows an advanced frame from the one on the left.

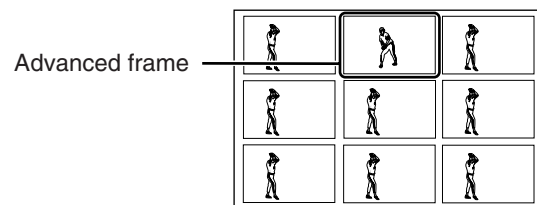

Each press of **STROBE** advances the frame one by one. Pressing **PLAY** instead of **STROBE** advances each frame in normal playback speed with a time delay over the whole 9 frames. (The sound is muted.)

### To return to the normal screen

Press and hold **STROBE** for more than 1 second.

### NOTES:

- If you press and hold **STROBE** for more than 1 second during playback, 9 pictures also appear but they advance in normal playback speed with a time delay. (The sound is muted.)
- You can perform the above operation using **II** on the center unit.

## Frame-by-frame playback



### ■ During playback

- 1 Press **PAUSE** at the point which you want to view frame by frame pictures.

Playback pauses.

- 2 Press **PAUSE** repeatedly.

- Each time you press the button, the still picture advances to the next frame.

### To return to normal playback

Press **PLAY**.

### NOTE:

You can perform the above operation using **II** on the center unit.

# DVD player operations

## Playing back in slow-motion

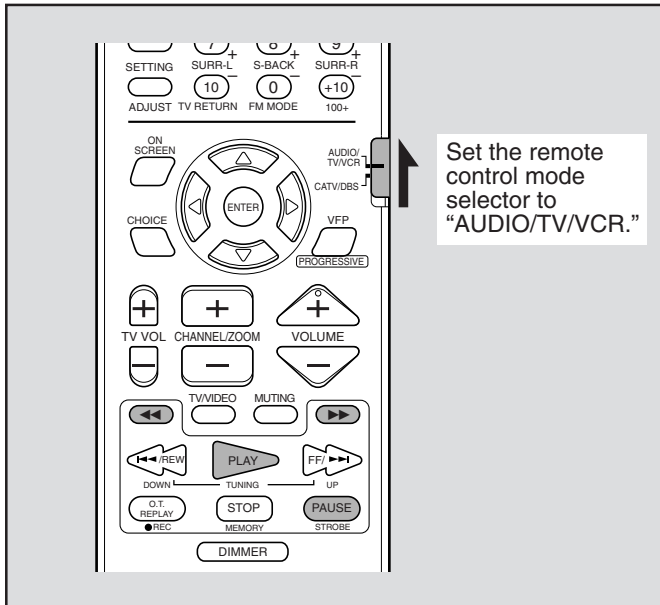

### ■ During playback

1 Press PAUSE at the point where you want to start slow-motion playback.

The system pauses playback.

2 Press ►► or ◀◀.

- To play back in forward slow-motion playback, press ►►.
- To play back in reverse slow-motion playback, press ◀◀.

Each time you press the button, the playback speed changes as follows.

Forward:



Reverse:



### To pause slow-motion playback

Press PAUSE.

### To return to normal playback

Press PLAY.

### NOTES:

- You cannot listen to the sound during slow-motion playback.
- Reverse slow-motion playback is not possible for VCDs and SVCDs.

## Zooming in and out

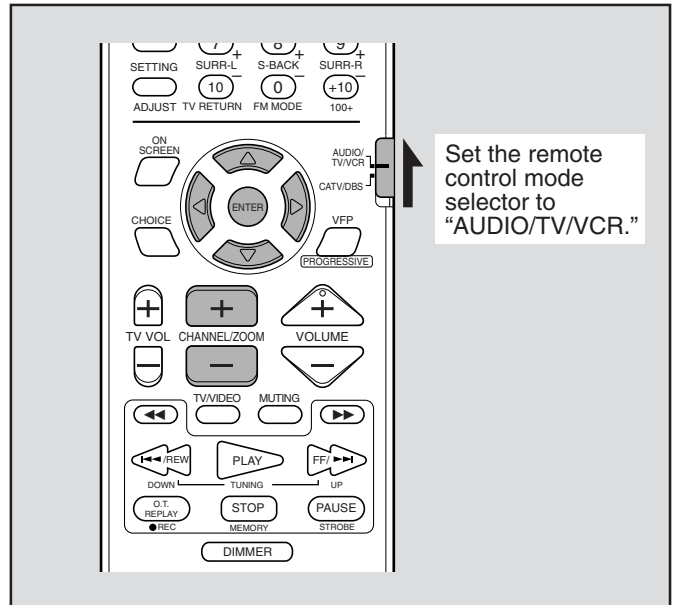

### ■ During playback

1 Press ZOOM + to zoom in or ZOOM – to zoom out.

Each time you press ZOOM + or ZOOM –, the magnification ratio changes as follows.

x 1/8	⇄	x 1/4	⇄	x 1/2	⇄	normal size	⇄
x 2	⇄	x 4	⇄	x 8	⇄	x 16	⇄
x 32	⇄	x 64	⇄	x 128	⇄	x 256	⇄
x 512	⇄	x 1024					

Ex.: When x4 zoom-in is selected.

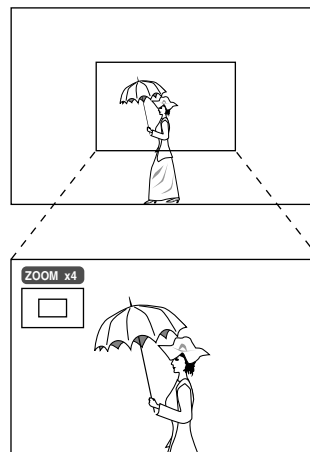

2 Only when zoomed in: press Cursor ►/◀/▼/▲ to move the zoomed-in position .

### To return to normal playback

Press ENTER.

### NOTE:

While zoomed in, the picture may look coarse.



## Changing the VFP setting



The VFP (Video Fine Processor) function enables you to adjust the picture character according to the type of programming, picture tone or personal preferences.

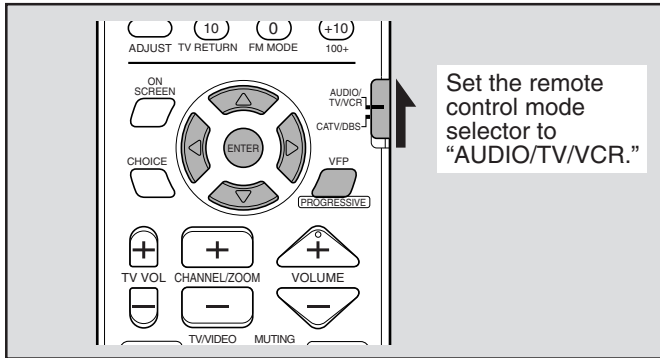

Before you start, remember...

There is a time limit in doing the following steps. If the setting is canceled before you finish, start from step 1 again.

### ■ During playback

#### 1 Press VFP.

The VFP setting screen appears on the TV.

Ex.: When "NORMAL" is selected.

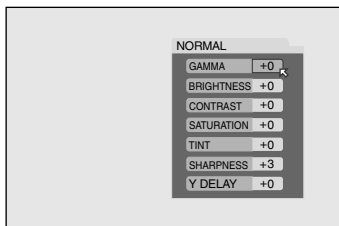

#### 2 Press Cursor ►/◄ repeatedly to select the VFP mode.

Each time you press the button, the VFP mode changes as follow.

**NORMAL** ⇄ **CINEMA** ⇄ **USER 1** ⇄ **USER 2** ⇄  
(back to the beginning)

**NORMAL** : Normally, select this.  
**CINEMA** : Suitable for a movie source.  
**USER 1, USER 2** : You can adjust parameters affecting the appearance of picture and also store the settings (see the right).

#### To erase the VFP setting screen

Press VFP.



You cannot adjust the picture appearance when selecting "NORMAL" and "CINEMA."

### ■ To adjust the appearance of picture

When selecting "USER 1" or "USER 2," you can adjust the appearance of picture.

#### 1 Press VFP, then press Cursor ►/◄ repeatedly to select "USER 1" or "USER 2."

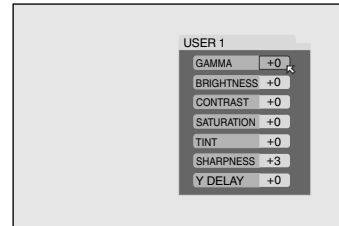

#### 2 Press Cursor ▼/▲ repeatedly to select a parameter you want to adjust.

Adjust the parameters so the picture you are viewing appears as the way you prefer.

##### • GAMMA:

Adjust this if the neutral color is bright or dark. The brightness of dark and bright portion is maintained. Available range: -4 (darkest) to +4 (brightest)

##### • BRIGHTNESS:

Adjust this if the picture is bright or dark on the whole. Available range: -16 (darkest) to +16 (brightest)

##### • CONTRAST:

Adjust this if the far and near position is unnatural. Available range: -16 to +16

##### • SATURATION:

Adjust this if the picture is whitish or blackish. Available range: -16 (most blackish) to +16 (whitest).

##### • TINT:

Adjust this if the human skin color is unnatural. Available range: -16 to +16

##### • SHARPNESS:

Adjust this if the picture is indistinct. Available range: +0 to +3

##### • Y DELAY:

Adjust this if the picture looks separately/overlapped. Available range: -2 to +2.

#### 3 Press ENTER.

VFP parameters list disappears, and the following pop-up window for the selected item appears on the TV.

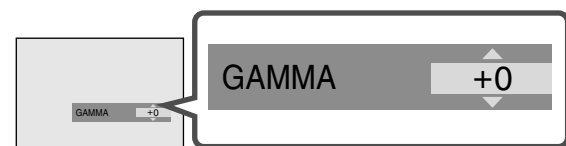

#### 4 Press Cursor ▼/▲ repeatedly to change the setting, then ENTER.

Your adjustment is stored and the current VFP parameters list appear again.

#### 5 Repeat steps 2—4 to adjust other parameters.

#### To erase the VFP setting screen

Press VFP.

#### To activate your setting

Press VFP, then press Cursor ►/◄ repeatedly to select "USER 1" or "USER 2."



The VFP setting screen disappear if no operation is done for more than 10 seconds.



# DVD player operations

## Playing back in the desired order—Program play



- You can play up to 99 tracks in desired order.
- You can program the same track repeatedly.
  - This function is not available for DVD.

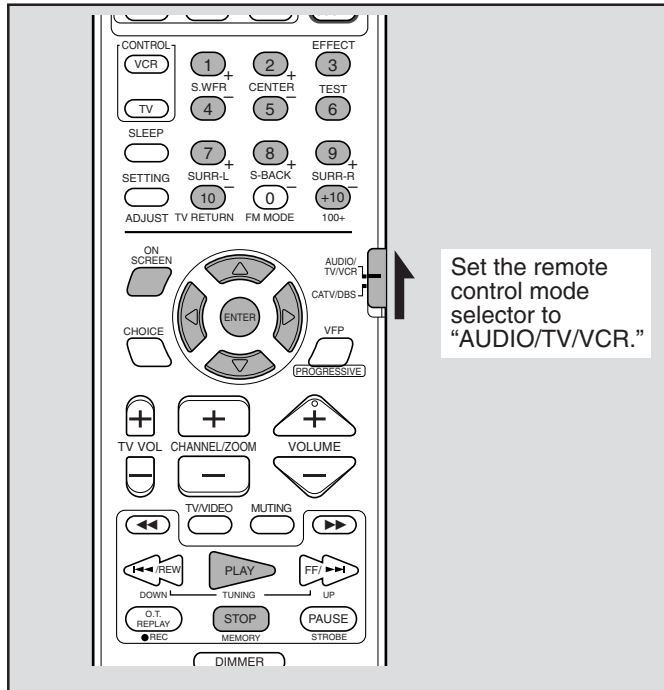

### ■ While stopped

- 1 Press ON SCREEN twice.  
The on-screen bar appears on the TV.
- 2 Press Cursor  $\blacktriangleright/\blacktriangleleft$  repeatedly to move  $\curvearrowright$  to **PROG.**, then press ENTER.  
The program screen appears on the TV.

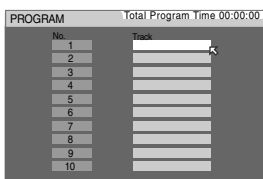

- 3 Press the number buttons (1–10, +10) to enter a track number you want to program.  
Ex.:  
To select 3, press 3.  
To select 14, press +10 then 4.  
To select 40, press +10, +10, +10 then 10.

Total program time is shown.

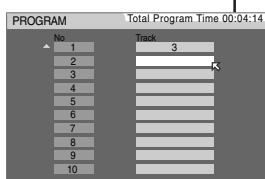

- 4 Repeat step 3 to program other tracks.  
• Entering a track number in the last step shows the next step on the screen.

## 5 Press PLAY.

- When playing a VCD or SVCD, the program screen goes off.  
Playback starts in the programmed order.
- Once all of the programmed tracks have been played, program play stops.

### To erase a programmed step

- Press Cursor  $\blacktriangleup/\blacktriangledown$  to move  $\curvearrowright$  to the step you want to erase, then press STOP.  
To program the next steps again, press Cursor  $\blacktriangledown$  repeatedly to move  $\curvearrowright$  to the blank step, then repeat step 3.

### To stop the program play

- Press STOP.  
The program screen appears again.
- To edit your program, repeat steps 3 and 4.

### To cancel the program play

- Clear the program you made as follows:
- 1 Press STOP to stop playback.
  - 2 Press ON SCREEN to appear the on-screen bar.
  - 3 Press STOP.
- You can also clear the program by ejecting the disc or turning off the system.

### To erase the on-screen bar

- Press ON SCREEN.

## Playing back in random order—Random play



- This function is not available for DVD.

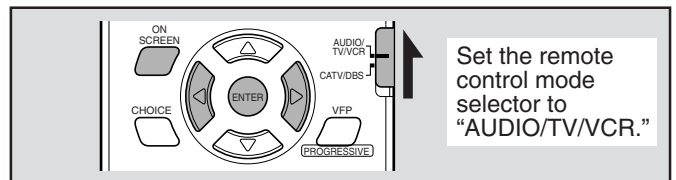

### ■ While stopped

- 1 Press ON SCREEN twice.  
The on-screen bar appears on the TV.
- 2 Press Cursor  $\blacktriangleright/\blacktriangleleft$  repeatedly to move  $\curvearrowright$  to **RND.**, then press ENTER.  
Playback starts in random order.  
• When all tracks have been played once, random play stops.

### To erase the on-screen bar

- Press ON SCREEN.

### To stop random play

- Press STOP. Playback stops and the random play is canceled.

### NOTES:

- During random play, you can skip back to the beginning of the current track by pressing  $\blacktriangleleft$ /REW, but cannot skip back to the tracks that have been played.
- During random play, pressing ENTER when **RND.** in the on-screen bar is selected cancels the random play and starts playing in the normal order.

## Repeat play

You can repeat playback of the current title or chapter (for DVD) or track (for VCD/SVCD/Audio CD). You can also repeat playback of a particular part.

### Repeating title, chapter, or tracks

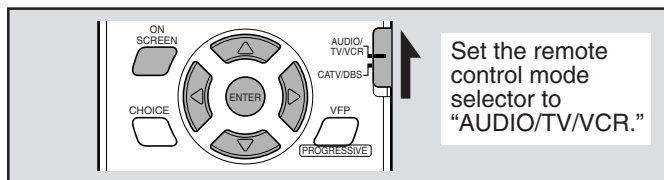

- For DVD :During playback
- For VCD/SVCD :During playback without activating PBC or while stopped
- For Audio CD :During playback or while stopped

#### 1 Press ON SCREEN twice.

The on-screen bar appears on the TV.

#### 2 Press Cursor >/< repeatedly to move to , then press ENTER.

The pop-up window appears under the on-screen bar.



#### 3 Press Cursor </> repeatedly to select repeat play mode.

- Each time you press the button, the repeat play mode changes as follow.

**For DVD:**

CHAPTER < TITLE < A-B < OFF <  
(back to the beginning)

**For VCD/SVCD/Audio CD:**

TRACK < ALL < A-B < OFF <  
(back to the beginning)

- CHAPTER** : Repeats current chapter.
- TITLE** : Repeats current title.
- TRACK** : Repeats current track.
- ALL** : Repeats all tracks of a disc.
- A-B** : Repeats a selected portion (see the right).
- OFF** : Cancels repeat play.



#### NOTE:

If you select "ALL" during random play, all tracks of the disc are played repeatedly in random order.

#### 4 Press ENTER.

Repeat play starts.

#### To cancel repeat play

Repeat from step 1, select "OFF" in step 3, then press ENTER.

#### To erase the on-screen bar

Press ON SCREEN.

## Repeating a particular portion —A-B repeat



You can repeat playback of a particular portion by specifying the beginning (point A) and the ending (point B).

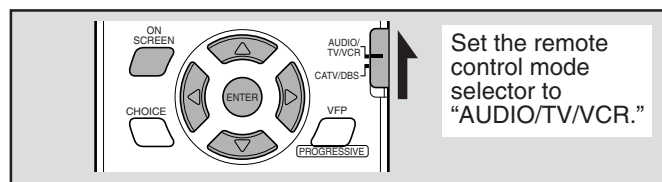

#### ■ During playback

#### 1 Press ON SCREEN twice.

The on-screen bar appears on the TV.

#### 2 Press Cursor >/< repeatedly to move to , then press ENTER.

The pop-up window appears under the on-screen bar.



#### 3 Press Cursor </> repeatedly to select "A-B."

#### 4 Press ENTER at the point where you want to start repetition (point A).

The following display appears in the on-screen bar.



#### 5 Press ENTER at the point where you want to end repetition (point B).

A-B repeat playback starts. The selected portion (between points A and B) is played continuously.



#### To cancel A-B repeat play

Repeat from step 1, select "OFF" in step 3, then press ENTER.

#### To erase the on-screen bar

Press ON SCREEN.



#### NOTES:

- While playing back a DVD disc, A-B repeat play is possible only within the same title.
- "A-B" cannot be selected during program and random plays.
- "A-B" cannot be selected while stopped.

# MP3 disc playback

This system can play MP3 tracks (files) recorded on a CD-R or CD-RW. We call such a disc “MP3 disc” in this manual.

- **Before using the remote control, press DVD to change the remote control operation mode for the MP3 disc operations.**
- When playing back an MP3 disc, set “MP3/JPEG” on the PICTURE menu of the choice menu to “MP3” (see page 53).
- Turn on your TV, and select the correct input mode on the TV.

**!** If “⊗” appears on the TV screen when pressing a button, the disc cannot accept an operation you have tried to do.

## ■ NOTES for MP3 disc

- MP3 discs (either CD-R or CD-RW) require a longer read-out time. (The time differs depending on the complexity of the group (folder)/track (file) configuration.)
- When making an MP3 disc, select ISO 9660 Level 1 or Level 2 as the disc format.
- This system supports “multi-session” discs (up to 5 sessions).
- This system can not play “packet write” discs.
- This system can play MP3 files only with the following file extensions: “.MP3,” “.Mp3,” “.mp3,” and “.mp3.”
- ID3\* tags cannot be shown on the display.
  - \* An MP3 file can contain file information called “ID3 Tag” where its album name, performer, track title, etc. are recorded. There are two versions—ID3v1 (ID3 Tag version 1) and ID3v2 (ID3 Tag version 2).
- It is recommended that you make each MP3 file at a sampling rate of 44.1 kHz and at bit rate of 128 kbps. This system cannot play back files recorded at the rate of under 64 kbps.
- If both MP3 files and JPEG files are recorded on a disc, set the MP3/JPEG setting on the PICTURE menu to “MP3.” (See page 53.)
- Some MP3 discs may not be played back because of their disc characteristics or recording conditions.

## ■ To start playback

### Load an MP3 disc, then press PLAY.

The system starts playback.

The following information appears on the display, and the MP3 CONTROL screen (see page 47) appears on the TV.

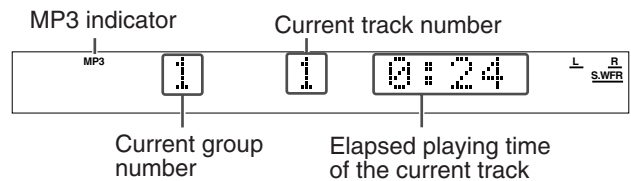

### To stop playback temporarily

Press PAUSE (or **||** on the center unit).

To start playback again, press PLAY (or **▶** on the center unit).

### To skip groups forward

Press Cursor **▶**.

### To skip groups backward

Press Cursor **◀**.

### To skip tracks forward

Press FF/▶▶ (or Cursor **▼** (or ▶▶ on the center unit) as many times as required.

### To skip to the beginning of the current track

Press I◀◀/REW (or I◀◀ on the center unit) once.

### To skip tracks backward

Press I◀◀/REW or Cursor **▲** (or I◀◀ on the center unit) as many times as required.

### To stop playback completely

Press STOP (or **■** on the center unit).

## Basic operation

### NOTES:

- The following functions are not available for MP3 disc playback:  
Program play, random play, repeat play, fast-forward/reverse playback, and using on-screen bar and choice menus
- Some tracks on an MP3 disc are skipped and may not be played back normally.

### From the remote control ONLY:

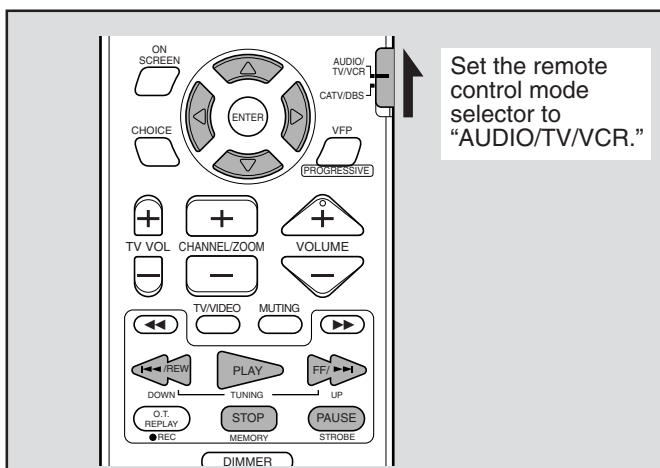

## Operating through the MP3 CONTROL screen

You can search and play the desired groups and tracks through the MP3 CONTROL screen.

### ■ MP3 CONTROL screen

The following screen appears on the TV when loading an MP3 disc.

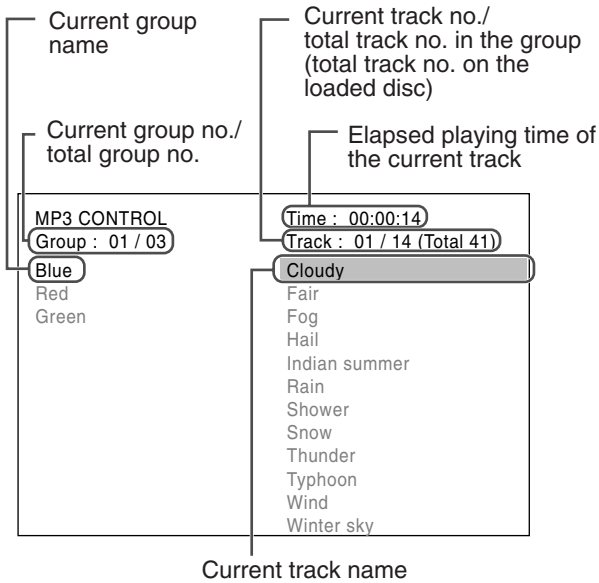

### NOTES:

- Some group and track names may not be shown correctly because of the recording condition.
- The order of groups and tracks on a MP3 disc may be shown differently from the order shown on your personal computer.
- The MP3 CONTROL screen can show up to 12 groups and tracks at a time. Pressing Cursor  $\blacktriangleright/\blacktriangleleft/\blacktriangledown/\blacktriangleup$  repeatedly shows the hidden groups and tracks one by one.

## ■ Operations

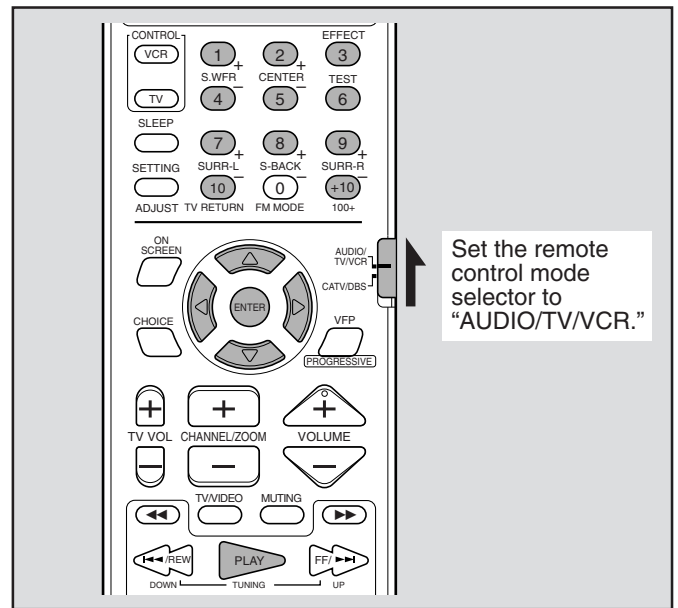

- 1 Press Cursor  $\blacktriangleright/\blacktriangleleft$  to select a group.
- 2 Press Cursor  $\blacktriangledown/\blacktriangleup$  to select a track you want to hear, then press PLAY or ENTER.

### To start playback from the specified track number

Press the number buttons (1–10, +10) to enter the track number.

Ex.:

- To select 3, press 3.
- To select 14, press +10 then 4.
- To select 24, press +10, +10, then 4.
- To select 110, press +10 ten times, then 10.

The entered number appears in the track number indication, then playback starts from the track you have specified.

# JPEG disc playback

This system can play JPEG files recorded on a CD-R or CD-RW. We call such a disc a “JPEG disc” in this manual.

- **Before using the remote control, press DVD to change the remote control operation mode for the JPEG disc operations.**
- When playing back a JPEG disc, set “MP3/JPEG” on the PICTURE menu of the choice menu to “JPEG” (see page 53).
- Turn on your TV, and select the correct input mode on the TV.

! If “⊗” appears on the TV screen when pressing a button, the disc cannot accept an operation you have tried to do.

## NOTES for JPEG disc

- JPEG discs (either CD-R or CD-RW) require a longer read-out time. (The time differs depending on the complexity of the group (folder)/file configuration.)
- When making a JPEG disc, select ISO 9660 Level 1 or Level 2 as the disc format.
- This system supports “multi-session” discs (up to 5 sessions).
- This system cannot play “packet write” discs.
- This system can play JPEG files only with the following file extensions: “.jpg,” “.jpeg,” “.JPG,” “.JPEG” and any upper case and lower case combination (such as “.Jpg”).
- It is recommended to record a file at 640 x 480 resolution. (If a file has been recorded at a resolution of more than 640 x 480, it will take a longer time to be shown.)
- If both JPEG files and MP3 files are recorded on a disc, set the MP3/JPEG setting on the PICTURE menu to “JPEG.” (See page 53.)
- This system can play only baseline JPEG files\*. Progressive JPEG files\* or lossless JPEG files\* cannot be played. Files having other format may not be played back.
  - \* Baseline JPEG format: Used for digital cameras, web, etc.
  - Progressive JPEG format: Used for web.
  - Lossless JPEG format: An old type and rarely used now.
- Some JPEG discs may not be played back because of their disc characteristics or recording conditions.

## Slide-show

You can see the still pictures one after another automatically —slide-show.

### NOTES:

- The following functions are not available for JPEG disc playback:  
Program play, random play, repeat play, fast-forward/reverse playback, and on-screen bar and choice menus
- If a black screen continuously appears in the slide-show playback:  
The file currently played may be non-baseline JPEG file. In this case, select a playable file (a baseline JPEG file) again. (e.g., pressing STOP or MENU to show the JPEG control screen, etc.)  
Note that it may take a long time to select another file.
- Some files on a JPEG disc may be shown distortedly.

From the remote control ONLY:

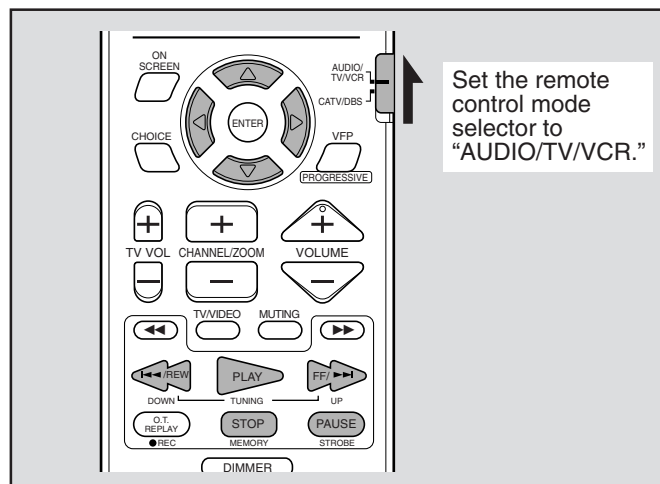

## To start slide-show playback

Load an JPEG disc, then press PLAY.

The slide-show playback starts.

- Each file (still picture) is shown on the TV for about 3 seconds, then changed to the next file one after another. After all files of one group have been played, files of the next group are played back.

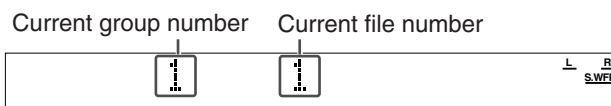

### To skip groups forward

Press Cursor ►.

### To skip groups backward

Press Cursor ◀.

### To skip files forward

Press FF/▶▶ or Cursor ▼ (or ▶▶ on the center unit).

### To skip files backward

Press ◀◀/REW or Cursor ▲ (or ◀◀ on the center unit).

### To stop slide-show playback temporarily

Press PAUSE (or || on the center unit).

To start slide-show playback again, press PLAY (or ► on the center unit).

### To stop slide-show playback

Press STOP (or ■ on the center unit).

The JPEG CONTROL screen appears on the TV screen.



### NOTE:

Press buttons for operating after a whole picture appears on the display. The system cannot accept the operation even though you press buttons while showing a picture.

## Operating through the JPEG CONTROL screen

You can search and show the desired groups and files through the JPEG CONTROL screen.

### ■ JPEG CONTROL screen

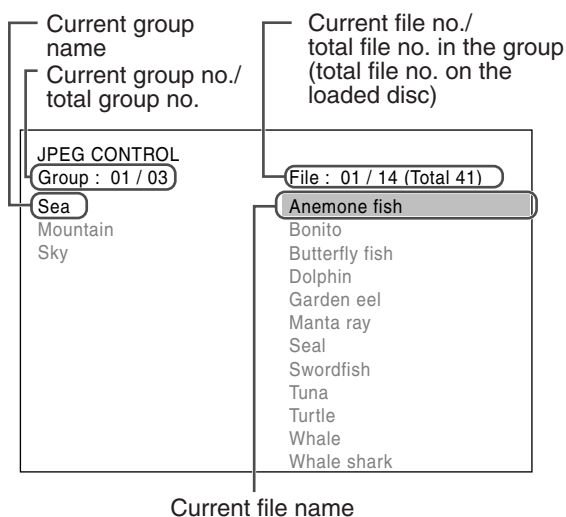

### NOTES:

- Some group and file names may not be shown correctly because of the recording condition.
- The order of groups and files on a JPEG disc may be shown differently from the order shown on your personal computer.
- The JPEG CONTROL screen can show up to 12 groups and files at a time. Pressing Cursor  $\blacktriangleright/\blacktriangleleft/\blacktriangledown/\blacktriangleup$  repeatedly shows the hidden groups and files one by one.

## ■ Operations

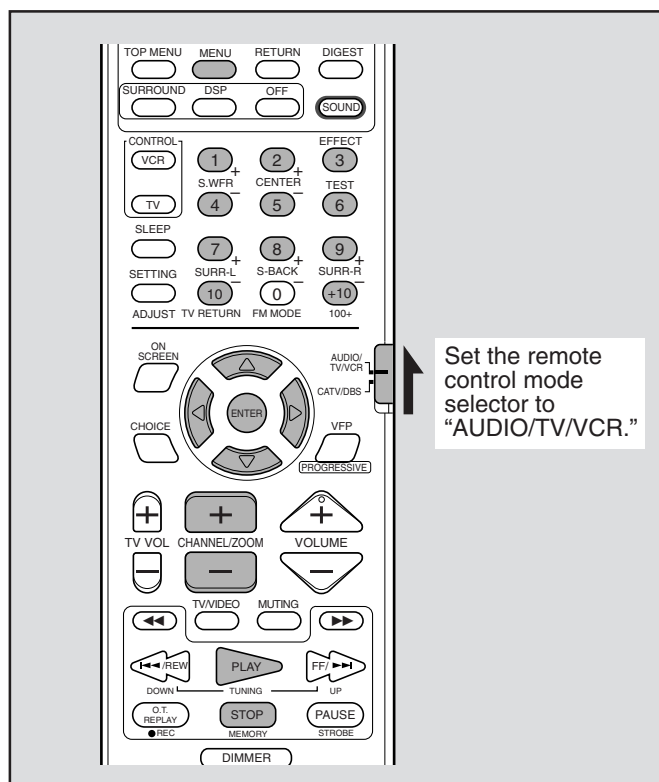

**1** Press Cursor  $\blacktriangleright/\blacktriangleleft$  to select a group.

**2** Press Cursor  $\blacktriangledown/\blacktriangleup$  to select a file you want to see, then press ENTER.

The selected picture is shown on the TV screen.

### To zoom in or out a still picture

Press ZOOM + or – after the selected picture is completely shown on the TV screen. (See also page 42.)

### To start the slide-show playback from the selected picture

Press PLAY (or  $\blacktriangleright$  on the center unit).

### To start playback with the specified file

Press the number buttons (1–10, +10) to enter the file number.

Ex.:

- To select 3, press 3.
- To select 14, press +10 then 4.
- To select 24, press +10, +10, then 4.
- To select 110, press +10 ten times, then 10.

The selected file number appears in the file number indication, then the slide-show playback starts from the file you have specified.

### To display the JPEG CONTROL screen

Press MENU or STOP (or  $\blacksquare$  on the center unit).



# Using the choice menus

You can adjust and select the initial settings through the choice menu on the TV.

- **Before using the remote control, press DVD to change the remote control operation mode.**
- When selecting any source other than DVD, you cannot use the choice menu.
- Turn on your TV, and select the correct input mode on the TV.
- You can change the language of the choice menus. See page 52.

## NOTES:

- You can only use the remote control for the choice menu operations.
- You cannot show the choice menu when an MP3 disc or a JPEG disc is loaded.

## Choice menus

### Configuration of the choice menus

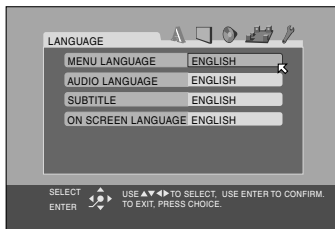

#### LANGUAGE menu (see page 52)

You can select the initial languages for the disc menu, audio, and subtitle.

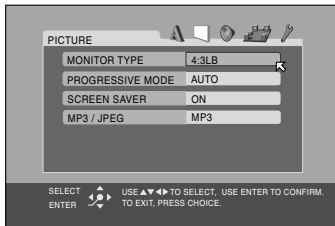

#### PICTURE menu (see page 53)

You can select items concerning a picture or monitor screen.



#### AUDIO menu (see page 54)

You can adjust the sound settings of this system through this menu.



#### SPK. SETTING menu (see page 55)

You can make the speaker settings, and adjust the output level of speakers.

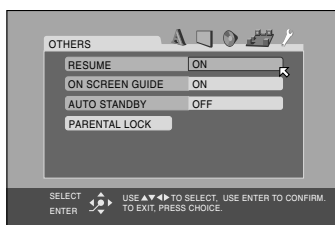

#### OTHERS menu (see page 56)

You can change the settings for some of the functions.

### Operation buttons for the choice menus

From the remote control ONLY:

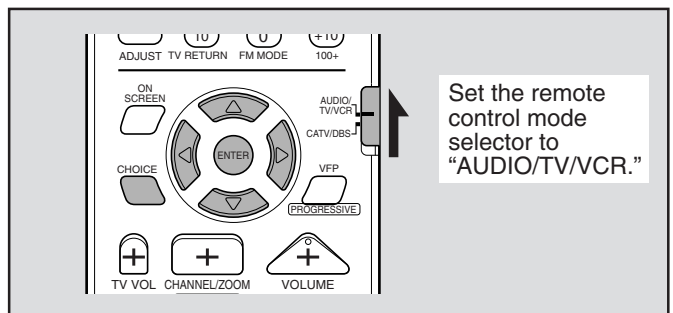

Button	To do
<b>CHOICE</b>	Display the choice menu on the TV. Each time you press the button, the choice menu appears and disappears alternately.
<b>Cursor ▶/◀</b>	Select a menu.
<b>Cursor ▼/▲</b>	Select an item.
<b>ENTER</b>	Move to sub-menu of the selected item or confirm the setting.



## Basic operating procedure

Before operating the choice menus, press DVD on the remote control to change the source to DVD.

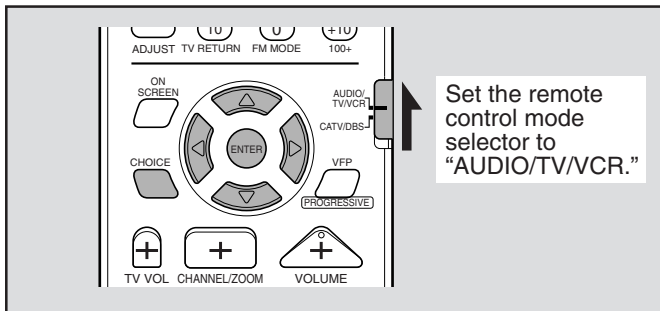

### 4 Press ENTER.

The pop-up window, listing the selectable options, appears on the choice menu.

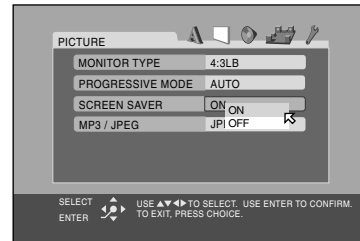

### 5 Press Cursor ▼/▲ repeatedly to select the desired option.

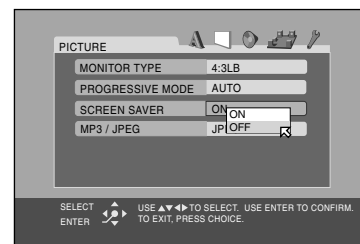

Ex.: When "OFF" is selected.

### 6 Press ENTER.

Your selection is stored.

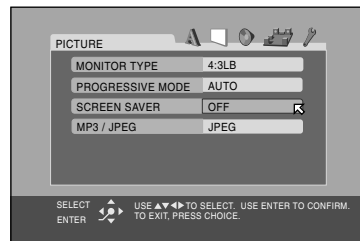

Ex.: When setting screen saver function on the PICTURE menu.

### 1 Press CHOICE.

The LANGUAGE menu appears on the TV.

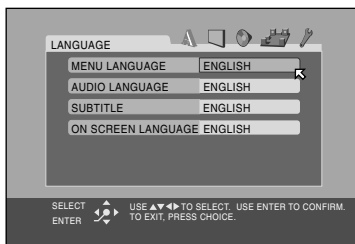

### 2 Press Cursor ►/◀ repeatedly so that the PICTURE menu appears on the screen

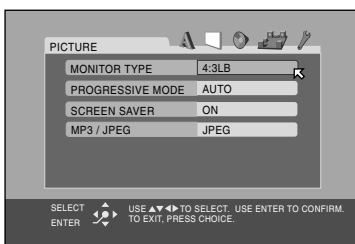

### 3 Press Cursor ▼/▲ repeatedly to move to "SCREEN SAVER."

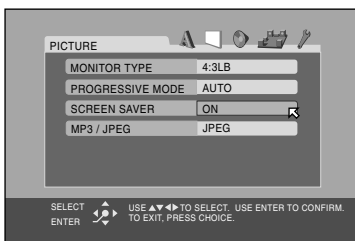

#### To set other items on the same choice menu

Repeat steps 3 to 6.

#### To set other items on a different choice menu

Repeat steps 2 to 6.

#### To exit from the choice menus

Press CHOICE.

#### NOTE:

Some items in the choice menus consist of sub-menus. The sub-menu appears by pressing ENTER. You can set the items on the sub-menu using Cursor ►/◀▼/▲ and ENTER.

# Using the choice menus

## LANGUAGE menu

You can select “MENU LANGUAGE,” “AUDIO LANGUAGE,” and “SUBTITLE” as initial languages only before playback.

- You can also select “AUDIO LANGUAGE” and “SUBTITLE” temporarily during playback (see page 37).

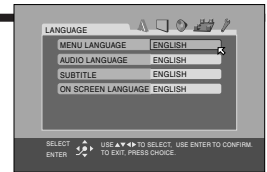

**Select your favorite language for “ON SCREEN LANGUAGE” first to make other operations easier.**

### ● ON SCREEN LANGUAGE

You can operate the system in the language you have selected.

**Select one of the languages—ENGLISH, CHINESE or SPANISH.**

### ● MENU LANGUAGE

Some discs have disc menus in multiple languages. You can select your favorite language you use while operating the DVD’s own menu.

**Select one of the languages or language codes from AA to ZU (see “Language codes list” below) as the disc menu language.**

### ● AUDIO LANGUAGE

Some discs have multiple audio languages. You can select your favorite language you listen to while watching a DVD.

**Select one of the languages or language codes from AA to ZU (see “Language codes list” below).**

### ● SUBTITLE

Some discs have multiple subtitle languages. You can select your favorite language you read while watching a DVD.

**Select one of the languages or language codes from AA to ZU (see “Language codes list” below) or “OFF (no subtitle).”**



**NOTE:**  
When the language you have selected for MENU LANGUAGE, AUDIO LANGUAGE, and SUBTITLE is not recorded on a disc, the original language is used automatically.

## Language codes list

AA	Afar	GL	Galician	ML	Malayalam	SO	Somali
AB	Abkhazian	GN	Guarani	MN	Mongolian	SQ	Albanian
AF	Afrikaans	GU	Gujarati	MO	Moldavian	SR	Serbian
AM	Ameharic	HA	Hausa	MR	Marathi	SS	Siswati
AR	Arabic	HI	Hindi	MS	Malay (MAY)	ST	Sesotho
AS	Assamese	HR	Croatian	MT	Maltese	SU	Sundanese
AY	Aymara	HU	Hungarian	MY	Burmese	SV	Swedish
AZ	Azerbaijani	HY	Armenian	NA	Nauru	SW	Swahili
BA	Bashkir	IA	Interlingua	NE	Nepali	TA	Tamil
BE	Byelorussian	IE	Interlingue	NL	Dutch	TE	Telugu
BG	Bulgarian	IK	Inupiak	NO	Norwegian	TG	Tajik
BH	Bihari	IN	Indonesian	OC	Occitan	TH	Thai
BI	Bislama	IS	Icelandic	OM	(Afan) Oromo	TI	Tigrinya
BN	Bengali, Bangla	IW	Hebrew	OR	Oriya	TK	Turkmen
BO	Tibetan	JI	Yiddish	PA	Panjabi	TL	Tagalog
BR	Breton	JW	Javanese	PL	Polish	TN	Setswana
CA	Catalan	KA	Georgian	PS	Pashto, Pushto	TO	Tonga
CO	Corsican	KK	Kazakh	PT	Portuguese	TR	Turkish
CS	Czech	KL	Greenlandic	QU	Quechua	TS	Tsonga
CY	Welsh	KM	Cambodian	RM	Rhaeto-Romance	TT	Tatar
DA	Danish	KN	Kannada	RN	Kirundi	TW	Twi
DZ	Bhutani	KO	Korean (KOR)	RO	Rumanian	UK	Ukrainian
EL	Greek	KS	Kashmiri	RU	Russian	UR	Urdu
EO	Esperanto	KU	Kurdish	RW	Kinyarwanda	UZ	Uzbek
ET	Estonian	KY	Kirghiz	SA	Sanskrit	VI	Vietnamese
EU	Basque	LA	Latin	SD	Sindhi	VO	Volapuk
FA	Persian	LN	Lingala	SG	Sangho	WO	Wolof
FI	Finnish	LO	Laothian	SH	Serbo-Croatian	XH	Xhosa
FJ	Fiji	LT	Lithuanian	SI	Singhalese	YO	Yoruba
FO	Faroese	LV	Latvian, Lettish	SK	Slovak	ZU	Zulu
FY	Frisian	MG	Malagasy	SL	Slovenian		
GA	Irish	MI	Maori	SM	Samoan		
GD	Scots Gaelic	MK	Macedonian	SN	Shona		

# PICTURE menu

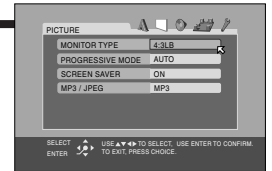

## ● MONITOR TYPE

You can select the monitor type to match your TV when you play DVDs recorded in the picture's height/width ratio of 16:9.

### Select one of the following settings:

**16:9 NORMAL (Wide television conversion) :**  
: Select when the aspect ratio of your TV is fixed to 16:9 (wide TV). The system automatically converts the picture width to fit 16:9 when playing back a picture whose aspect ratio is 4:3.

**16:9 AUTO (Wide television conversion) :**  
: Select when the aspect ratio of your TV is 16:9 (wide TV).

**4:3 LB (Letter Box conversion) :**  
: Select when the aspect ratio of your TV is 4:3 (conventional TV). While viewing a wide screen picture, the black bars appear on the top and the bottom of the screen.

**4:3 PS (Pan Scan conversion) :**  
: Select when the aspect ratio of your TV is 4:3 (conventional TV). While viewing a wide screen picture, the black bars do not appear; however, the left and right edges of the pictures will not be shown on the screen.

**16:9 MULTI NORMAL**

**16:9 MULTI AUTO**

**4:3 MULTI LB**

**4:3 MULTI PS**

: These "MULTI" options should be selected when you connect the system to a multi-color system TV. If you select one of these options, the system outputs a PAL or NTSC video signal according to the disc, regardless of the VIDEO OUT SELECT switch setting (see page 7).

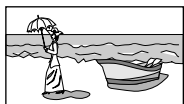

Ex.: 16:9



Ex.: 4:3 LB

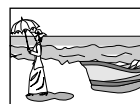

Ex.: 4:3 PS

- Even if "4:3 PS" is selected, the screen size may become "4:3 LB" when playing back some DVD. This depends on how they are recorded.
- When you select "16:9 NORMAL" for a picture whose aspect ratio is 4:3, the picture slightly changes due to the process for converting the picture width.

## ● PROGRESSIVE MODE

You can select the progressive mode according to the picture type (film or video source). Normally, set to "AUTO." If the playback picture is unclear or noisy, or the oblique lines of the picture are rough, try to change to other modes.

### Select one of the following settings:

**VIDEO** : Suitable for playing back a video source disc.

**FILM** : Suitable for playing back a film or progressive source disc.

**AUTO** : Used to play a disc containing both video and film source materials. This system recognizes the picture type (film or video source) of the current disc according to the disc information.

## ● SCREEN SAVER

You can activate or deactivate the screen saver function.

### Turn ON or OFF the screen saver function.

**ON** : The picture on the TV becomes dark when no operation is done for about 5 minutes.

**OFF** : The screen saver function does not work.

## ● MP3/JPEG

If both MP3 tracks (files) and JPEG files are recorded on a disc, you can select which files to play.

### Select one of the following settings:

**MP3** : Select when playing back MP3 tracks (files).

**JPEG** : Select when playing back JPEG files.

# Using the choice menu

## AUDIO menu

You can also adjust the following items using SETTING/ADJUST button on the remote control (see page 26).

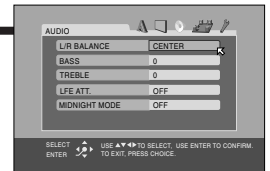

### ● L/R BALANCE

If the sounds through the front speakers are not well-balanced, adjust the front speaker output balance.

**Adjust the front speakers' output balance within the range of "R -21" to "L -21."**

- "R -21": no sound comes out of the right speaker.
- "L -21": no sound comes out of the left speaker.
- "CENTER": output levels of both speakers are identical.

### ● BASS, TREBLE

You can adjust the bass and treble sounds as you like.

**Adjust the bass or treble level of the front speaker signals in 2 step intervals.**

- Adjustable range: "-10" to "10."

### ● LFE ATT.

The Low Frequency Effect attenuator diminishes the distortion of the bass sound from the subwoofer when playing back Dolby Digital or DTS Digital Surround software.

**Turn ON or OFF the LFE attenuator:**

---

ON (-10 dB) : Select to diminish the distortion of the bass sound from the subwoofer.

---

OFF (0 dB) : Select to cancel the function.

---

### ● MIDNIGHT MODE

You can reinforce the bass sound if bass sounds are not sufficient.

**Select one of the following settings:**

---

1 : Select when you want to compress the dynamic range a little.

---

2 : Select when you want to fully compress the dynamic range (useful at night).

---

OFF : Select when you want to enjoy surround with its full dynamic range (no effect applied).

---

# SPK. SETTING menu



## ● SIZE

Select this to enter the SIZE sub-menu.

- You can also set the speaker sizes using SETTING/ADJUST buttons on the remote control (see page 24).

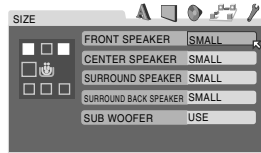

### Select one of the sizes for each speaker.

LARGE	: Select when the cone speaker size is larger than 12 cm.
SMALL	: Select when the cone speaker size is smaller than 12 cm.
NONE	: (Only for "SURROUND BACK SPEAKER") Select when no speaker is connected.

#### ! CAUTION:

When using the supplied speakers, select "SMALL" for each. Selecting "LARGE" will damage the speakers.

#### NOTES:

- If you have selected "SMALL" for the front speakers, you cannot select "LARGE" for the center, surround, and surround back speakers.
- If you have selected "SMALL" for the surround speakers, you cannot select "LARGE" for the surround back speaker.

## SUB WOOFER

This item fixed to "USE."

### To go back to the SPK. SETTING menu

Press Cursor ►/◀.

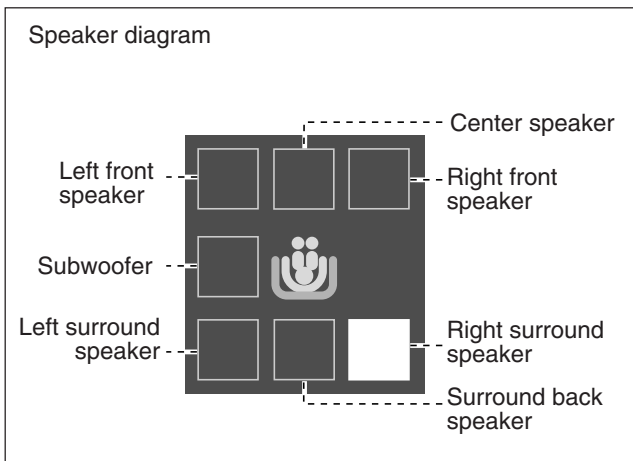

## ● LEVEL

Select this to enter the LEVEL sub-menu.

- You can also select sound output levels using the number buttons on the remote control (see pages 17 and 32).

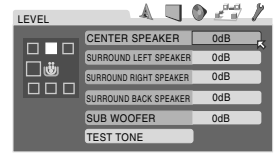

### Adjust the output level within the range of -10 dB to +10 dB for each speaker in 1 step interval.

You can also adjust the speaker output levels checking the test tone from each speaker.

- Adjust the speaker levels so that you can hear the sound through all the speakers at the same level.

## TEST TONE

Select this to start or stop the test tone.

### To go back to the SPK. SETTING menu

Press Cursor ►/◀.

#### NOTES:

- When "NONE" is selected for the surround back speaker, the test tone does not come out of the surround back speaker and you cannot adjust the surround back speaker's output level.
- The test tone for the subwoofer does not output.

## ● DISTANCE

Select this to enter the DISTANCE sub-menu.

- You can also set the distance from your listening point using SETTING/ADJUST button on the remote control (see page 25 for details).

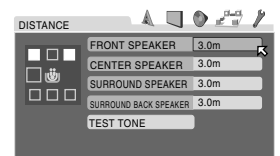

### Set the distance from the listening point to each speaker with the range of 0.3 m to 9.0 m (in 0.3 m interval).

## TEST TONE

Select this to start or stop the test tone.

### To go back to the SPK. SETTING menu

Press Cursor ►/◀.

#### NOTES:

- If you have selected "NONE" for the surround back speaker, you cannot set the speaker distance for the surround back speaker.
- When "NONE" is selected for the surround back speaker, the test tone does not come out of the speaker.
- The test tone for the subwoofer does not output.

# Using the choice menu

## ● CROSS OVER

Small speakers cannot reproduce the bass sounds efficiently. If you use a small speaker in any position, this system automatically reallocates the bass sound elements assigned to the small speaker to the large speakers.

To use this function properly, set the crossover frequency level according to the size of the small speaker connected.

- If you have selected "LARGE" for all speakers, this function will not take effect.
- You can also set the crossover frequency using SETTING/ADJUST button on the remote control (see page 25).

Select one of the following settings:

80Hz	: Select when the cone speaker unit built in the speaker is about 12 cm.
100Hz	: Select when the cone speaker unit built in the speaker is about 10 cm.
120Hz	: Select when the cone speaker unit built in the speaker is about 8 cm.
150Hz	: Select when the cone speaker unit built in the speaker is about 6 cm.
200Hz	: Select when the cone speaker unit built in the speaker is less than 5 cm.

### ! CAUTION:

When using the supplied speakers, select "200Hz."



**NOTE:**  
Crossover frequency is not valid for the HEADPHONE mode.

## ● RETURN TO INITIAL

Select this to reset all speaker settings to the initial values.

# OTHERS menu

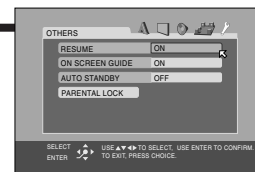

## ● RESUME

If you turn off the power while playing back a disc, the position where the playback has been stopped is stored. You can activate or deactivate the resume playback function.

The RESUME indicator lights up on the display when turning on the system if the resume function is activated. To resume playback from that position, press DVD or PLAY on the remote control.

- The resume playback function does not work for Audio CDs.

Select one of the following settings:

ON	: Select to activate this function.
OFF	: Select to deactivate it.

## ● ON SCREEN GUIDE

You can activate or deactivate the on-screen guide icons.

- Multi view angle :
- Subtitle :
- Audio language :
- Playback status : , , , etc.

The guide icons appear on the TV at the beginning of the operation with this function turned on.

Select one of the following settings:

ON	: Select to activate this function.
OFF	: Select to deactivate it.

- Subtitles (see page 37) and the information for zooming in (see page 42) appear on the display even though this setting is "OFF."

## ● AUTO STANDBY

When disc playback on the built-in DVD player ends and no operation is done for more than the specified time (60 or 30), the system is turned off automatically.

- This function takes effect only when DVD is selected as the source.

Select one of the following settings:

60	: Turns off the system if no operation is done for 60 minutes.
30	: Turns off the system if no operation is done for 30 minutes.
OFF	: Select to deactivate the function.

- If the sleep timer (see page 18) and Auto Standby are used at the same time, the one with the earlier shut-off time will turn off the system.

## ● PARENTAL LOCK

Select this to enter the PARENTAL LOCK sub-menu. You can restrict playback of a DVD containing violent scenes and those not suitable for your family members. (see "Restricting playback—Parental Lock" on page 57 for the detailed operations.)

- You can select "PARENTAL LOCK" only before playback.

## Restricting playback—Parental Lock

You can restrict playback of a DVD containing violent scenes and those not suitable for your family members. Nobody can play such a disc unless this function is canceled.

- This setting takes effect only for the DVDs containing parental lock level information—Level 1 (most restrictive) to Level 8 (least restrictive).
- You can set the Parental Lock only while playback is stopped.
- **Before using the remote control, press DVD to change the remote control operation mode.**

### Setting Parental Lock

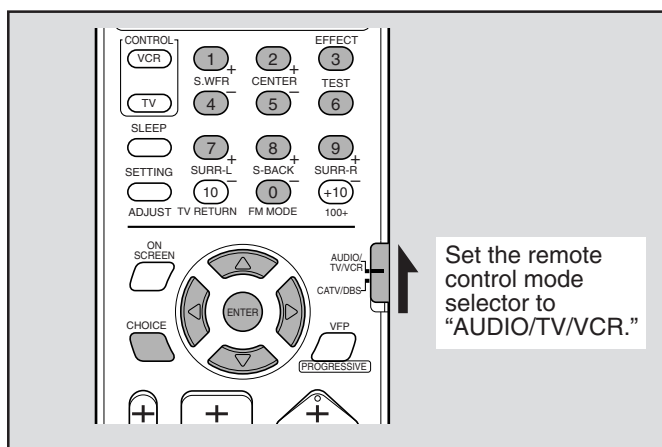

- 1 Press CHOICE, then press Cursor ►/◄ to display the OTHERS menu.
- 2 Press Cursor ▼/▲ repeatedly to move to “PARENTAL LOCK,” then press ENTER. The PARENTAL LOCK sub-menu appears on the TV.

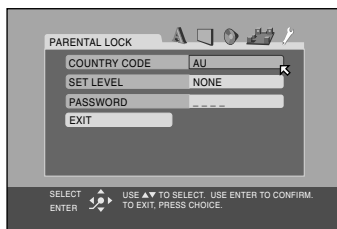

- 3 Press Cursor ▼/▲ repeatedly to move to “COUNTRY CODE,” then press ENTER. The pop-up window listing country codes appears.

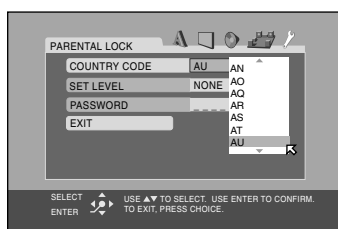

- 4 Press Cursor ▼/▲ repeatedly to select the country code, then press ENTER.

The moves to “SET LEVEL.”

- See “Country/area codes list for Parental Lock” on page 59.

- 5 Press ENTER.

The pop-up window listing Parental Lock levels appears.

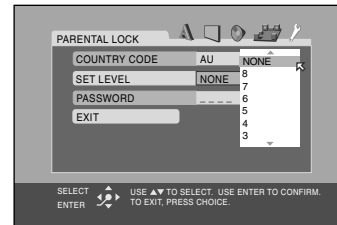

- 6 Press Cursor ▼/▲ repeatedly to set the level of restriction, then press ENTER.

The moves to “PASSWORD.”

- Select “NONE” to cancel this function.

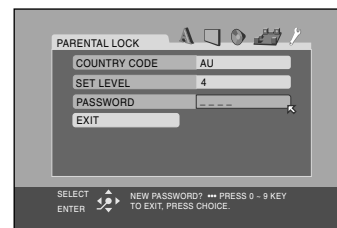

- 7 Press the number buttons (0–9) to enter a four digit number as your password, then press ENTER. The moves to “EXIT.”

- 8 Press ENTER.

The OTHERS menu appears again.

**To exit from the choice menu**  
Press CHOICE.

#### NOTE:

Remember your password by making a note of it. You need to enter your password to change the setting or release the lock. To change the setting, see page 58.



# Using the choice menu

## Changing the setting of Parental Lock

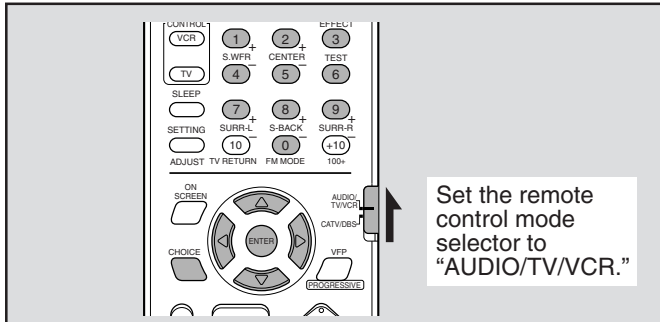

**1** Press CHOICE, then press Cursor  $\blacktriangleright/\blacktriangleleft$  to display the OTHERS menu.

**2** Press Cursor  $\blacktriangledown/\blacktriangleup$  repeatedly to move  $\blacktriangleright$  to "PARENTAL LOCK," then press ENTER.

The PARENTAL LOCK sub-menu appears on the TV.  
 • You can only move  $\blacktriangleright$  to "PASSWORD" or to "EXIT" before you enter your password.

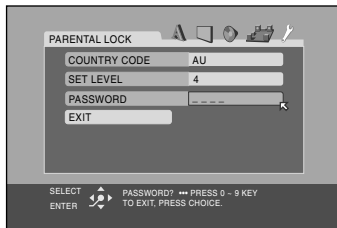

**3** Press the number buttons (0–9) to enter your password, then press ENTER.

The  $\blacktriangleright$  moves to "COUNTRY CODE."  
 • If you enter a wrong password, "WRONG! RETRY..." appears in the message area.  
 You cannot go to the next step before you enter the correct password.

**4** Press Cursor  $\blacktriangledown/\blacktriangleup$  repeatedly to move  $\blacktriangleright$  to the item you want to change, then press ENTER.

**5** Press Cursor  $\blacktriangledown/\blacktriangleup$  repeatedly to change the setting, then press ENTER.

**6** Press the number buttons (0–9) to enter your password, then press ENTER.  
 The new setting is stored.

### NOTES:

- You cannot set the Parental Lock before you set your password. (See page 57.)
- If you exit from the PARENTAL LOCK sub-menu before setting your password in step 6, the newly entered country code and Parental Lock level do not take effect, but previous settings are effective.
- When you enter wrong passwords more than three times,  $\blacktriangleright$  moves to "EXIT" automatically and Cursor  $\blacktriangledown/\blacktriangleup$  do not work. Press Cursor  $\blacktriangleright/\blacktriangleleft$  to exit from the PARENTAL LOCK sub-menu, then repeat from step 1.
- If you forget your password, enter "8888."

## Releasing Parental Lock temporarily

When you set a strict Parental Lock level, some discs may not be played back at all. When you load such a disc and try to play it, the following display appears on the TV screen. You can release Parental Lock temporarily.

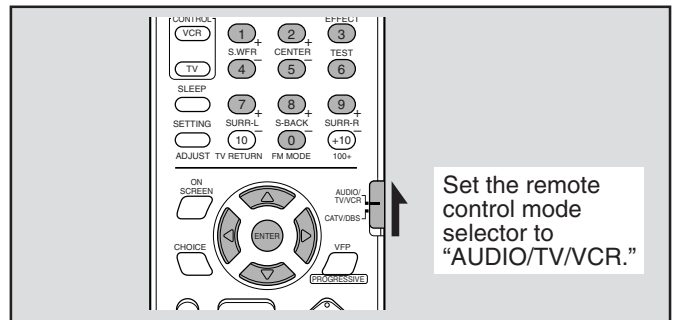
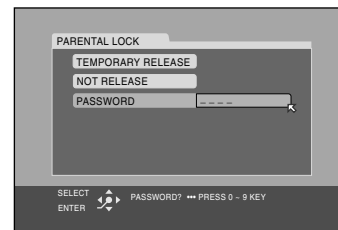

**1** Press Cursor  $\blacktriangledown/\blacktriangleup$  repeatedly to move  $\blacktriangleright$  to "TEMPORARY RELEASE", then press ENTER.

The  $\blacktriangleright$  moves to "PASSWORD."  
 • When selecting "NOT RELEASE," press  $\blacktriangleup$  to eject the disc.

**2** Press the number buttons (0–9) to enter your password.

Playback starts.  
 • If you enter a wrong password, "WRONG! RETRY..." appears in the message area.  
 You cannot play the disc before you enter the correct password.

### NOTE:

When you enter wrong passwords more than three times,  $\blacktriangleright$  moves to "NOT RELEASE" automatically and Cursor  $\blacktriangledown/\blacktriangleup$  do not work. Press  $\blacktriangleup$  to eject the disc.

## Country/area codes list for Parental Lock

AD	Andorra	ER	Eritrea	LA	Lao People's Democratic Republic	RW	Rwanda
AE	United Arab Emirates	ES	Spain			SA	Saudi Arabia
AF	Afghanistan	ET	Ethiopia	LB	Lebanon	SB	Solomon Islands
AG	Antigua and Barbuda	FI	Finland	LC	Saint Lucia	SC	Seychelles
AI	Anguilla	FJ	Fiji	LI	Liechtenstein	SD	Sudan
AL	Albania	FK	Falkland Islands (Malvinas)	LK	Sri Lanka	SE	Sweden
AM	Armenia	FM	Micronesia (Federated States of)	LR	Liberia	SG	Singapore
AN	Netherlands Antilles			LS	Lesotho	SH	Saint Helena
AO	Angola	FO	Faroe Islands	LT	Lithuania	SI	Slovenia
AQ	Antarctica	FR	France	LU	Luxembourg	SJ	Svalbard and Jan Mayen
AR	Argentina	FX	France, Metropolitan	LV	Latvia	SK	Slovakia
AS	American Samoa	GA	Gabon	LY	Libyan Arab Jamahiriya	SL	Sierra Leone
AT	Austria	GB	United Kingdom	MA	Morocco	SM	San Marino
AU	Australia	GD	Grenada	MC	Monaco	SN	Senegal
AW	Aruba	GE	Georgia	MD	Moldova, Republic of	SO	Somalia
AZ	Azerbaijan	GF	French Guiana	MG	Madagascar	SR	Suriname
BA	Bosnia and Herzegovina	GH	Ghana	MH	Marshall Islands	ST	Sao Tome and Principe
BB	Barbados	GI	Gibraltar	ML	Mali	SV	El Salvador
BD	Bangladesh	GL	Greenland	MM	Myanmar	SY	Syrian Arab Republic
BE	Belgium	GM	Gambia	MN	Mongolia	SZ	Swaziland
BF	Burkina Faso	GN	Guinea	MO	Macau	TC	Turks and Caicos Islands
BG	Bulgaria	GP	Guadeloupe	MP	Northern Mariana Islands	TD	Chad
BH	Bahrain	GQ	Equatorial Guinea	MQ	Martinique	TF	French Southern Territories
BI	Burundi	GR	Greece	MR	Mauritania	TG	Togo
BJ	Benin	GS	South Georgia and the South Sandwich Islands	MS	Montserrat	TH	Thailand
BM	Bermuda			MT	Malta	TJ	Tajikistan
BN	Brunei Darussalam	GT	Guatemala	MU	Mauritius	TK	Tokelau
BO	Bolivia	GU	Guam	MV	Maldives	TM	Turkmenistan
BR	Brazil	GW	Guinea-Bissau	MW	Malawi	TN	Tunisia
BS	Bahamas	GY	Guyana	MX	Mexico	TO	Tonga
BT	Bhutan	HK	Hong Kong	MY	Malaysia	TP	East Timor
BV	Bouvet Island	HM	Heard Island and McDonald Islands	MZ	Mozambique	TR	Turkey
BW	Botswana			NA	Namibia	TT	Trinidad and Tobago
BY	Belarus	HN	Honduras	NC	New Caledonia	TV	Tuvalu
BZ	Belize	HR	Croatia	NE	Niger	TW	Taiwan
CA	Canada	HT	Haiti	NF	Norfolk Island	TZ	Tanzania, United Republic of
CC	Cocos (Keeling) Islands	HU	Hungary	NG	Nigeria		
CF	Central African Republic	ID	Indonesia	NI	Nicaragua	UA	Ukraine
CG	Congo	IE	Ireland	NL	Netherlands	UG	Uganda
CH	Switzerland	IL	Israel	NO	Norway	UM	United States Minor Outlying Islands
CI	Côte d'Ivoire	IN	India	NP	Nepal		
CK	Cook Islands	IO	British Indian Ocean Territory	NR	Nauru	US	United States
CL	Chile			NU	Niue	UY	Uruguay
CM	Cameroon	IQ	Iraq	NZ	New Zealand	UZ	Uzbekistan
CN	China	IR	Iran (Islamic Republic of)	OM	Oman	VA	Vatican City State (Holy See)
CO	Colombia	IS	Iceland	PA	Panama		
CR	Costa Rica	IT	Italy	PE	Peru	VC	Saint Vincent and the Grenadines
CU	Cuba	JM	Jamaica	PF	French Polynesia		
CV	Cape Verde	JO	Jordan	PG	Papua New Guinea	VE	Venezuela
CX	Christmas Island	JP	Japan	PH	Philippines	VG	Virgin Islands (British)
CY	Cyprus	KE	Kenya	PK	Pakistan	VI	Virgin Islands (U.S.)
CZ	Czech Republic	KG	Kyrgyzstan	PL	Poland	VN	Viet Nam
DE	Germany	KH	Cambodia	PM	Saint Pierre and Miquelon	VU	Vanuatu
DJ	Djibouti	KI	Kiribati	PN	Pitcairn	WF	Wallis and Futuna Islands
DK	Denmark	KM	Comoros	PR	Puerto Rico	WS	Samoa
DM	Dominica	KN	Saint Kitts and Nevis	PT	Portugal	YE	Yemen
DO	Dominican Republic	KP	Korea, Democratic People's Republic of	PW	Palau	YT	Mayotte
DZ	Algeria			PY	Paraguay	YU	Yugoslavia
EC	Ecuador	KR	Korea, Republic of	QA	Qatar	ZA	South Africa
EE	Estonia	KW	Kuwait	RE	Réunion	ZM	Zambia
EG	Egypt	KY	Cayman Islands	RO	Romania	ZR	Zaire
EH	Western Sahara	KZ	Kazakhstan	RU	Russian Federation	ZW	Zimbabwe

# AV COMPU LINK remote control system

**AV COMPU LINK**

The AV COMPU LINK remote control system allows you to operate JVC TVs and VCRs through the center unit.

This system is equipped with the AV COMPU LINK-III, which adds a function to operate JVC's video components through the video components terminals. To use this remote control system, you need to connect the video components you want to operate, following the diagrams below and the procedure on the next page.

- Refer also to the manuals supplied with your video components.

## Connection 1: AV COMPU LINK connection

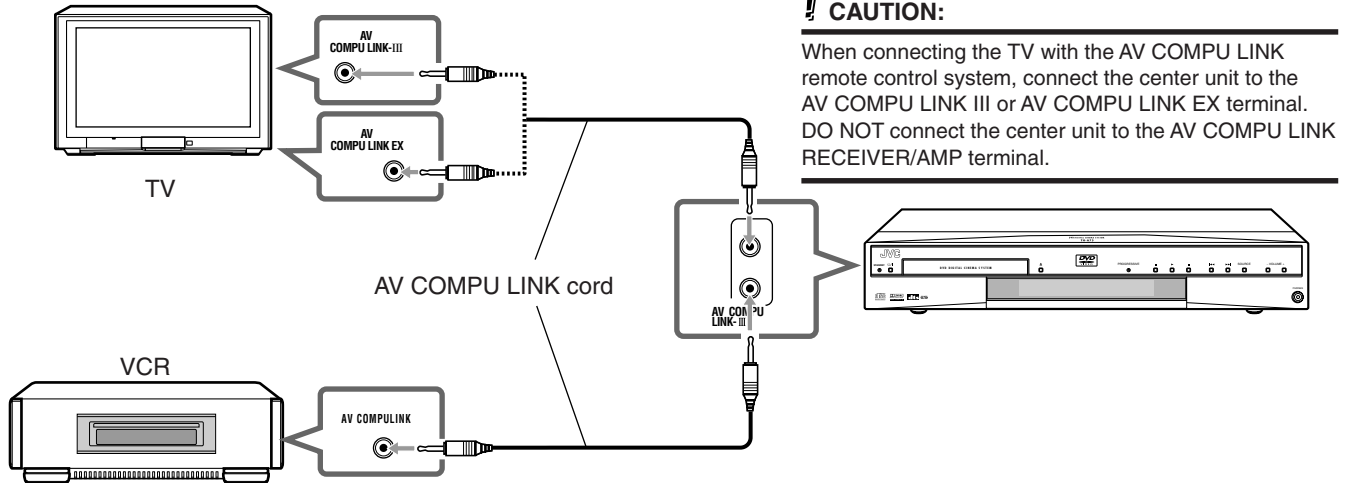

## Connection 2: Video cord connection

### Connecting TV and VCR

Connect the center unit to the TV and VCR through the same video terminals using one of the following:

- If the TV and VCR are equipped with S-video terminals
- If the TV and VCR are equipped with composite video terminals

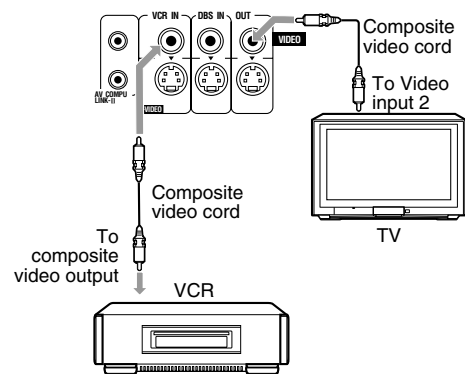
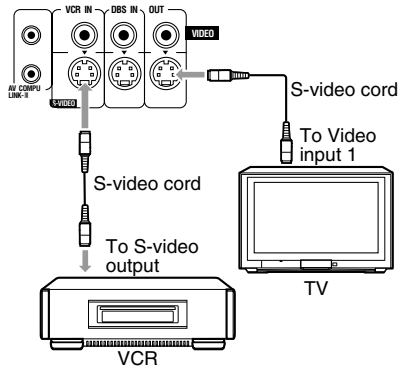

### Connecting TV only

Connect the TV using composite video cord, S-video cord or component video cord.

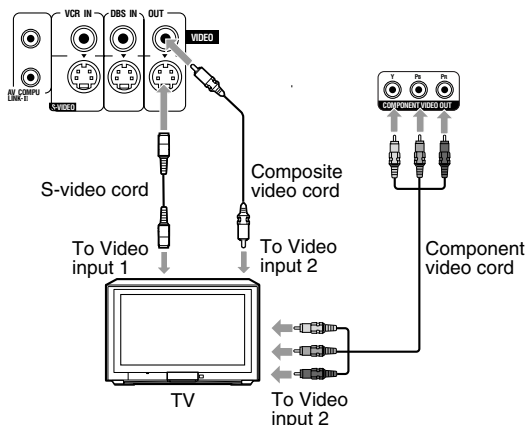

### NOTES:

- When connecting the center unit and a TV with the AV COMPU LINK EX terminal by using a component video cord, you cannot use the automatic selection of TV's input mode (see page 61).
- To use the automatic selection of TV's input mode correctly (see page 61), select the correct "M.OUT" setting (see page 25).

## Procedure for connection

- 1** If you have already plugged your VCR, TV and the center unit into the AC outlets, unplug their AC power cords first.
- 2** Connect the VCR, TV and the center unit using AV COMPU LINK cords (one cord is supplied).
  - See “Connection 1” on the previous page.
- 3** Connect between the audio output jacks on the VCR and the VCR AUDIO IN jacks on the center unit using the audio cord.
  - See page 13.
- 4** Connect the video input/output jacks on the VCR, TV and the center unit.
  - See “Connection 2” on the previous page.
- 5** Plug the AC power cords of the VCR, TV and the center unit into the AC outlets.
- 6** When turning on the TV for the first time after the AV COMPU LINK connection, turn the TV volume to the minimum using the TV volume control on the TV.
- 7** Turn on the connected components first, then turn on the center unit.
  - When turning on the VCR, use the remote control supplied with this system—press VCR .

## Available functions

The AV COMPU LINK remote control system allows you to use the functions listed below.

### One-touch video play

Simply by inserting a video cassette without its safety tab into the VCR, you can enjoy the video playback without setting other switches manually. This system automatically turns on and changes the source to VCR .

The TV automatically turns on and changes the input mode to the appropriate position so that you can view the playback picture.

When you insert a video cassette with its safety tab, press the play (▶) button on the VCR or on the remote control. So, you can get the same result.

### One-touch DVD play

Simply by starting playback on the built-in DVD player, you can enjoy the playback without setting other switches manually. The TV automatically turns on and changes the input mode to the appropriate position so that you can view the playback picture.

### Automatic selection of TV's input mode

When you select DVD, VCR, or DBS as the source to play on the center unit, the TV automatically changes the input mode to the appropriate position so that you can view the playback picture.

### Automatic Power On/Off

The TV and VCR turn on and off along with the center unit.

When you turn on the center unit;

- If the previously selected source is “DVD,” only the TV will turn on automatically.
- If the previously selected source is “VCR ,” the TV and VCR will turn on automatically.

When you turn off the center unit, the TV and VCR will turn off.



### NOTE:

*If you turn off the center unit while recording on the VCR, the VCR will not turn off, but continue recording.*

# Operating other manufacturers' video equipment

By changing the remote control signals from preset ones to the other manufacturers', you can use the remote control supplied for this system to operate other manufacturers' TVs, VCRs, CATV converters and DBS tuners.

- When operating other video equipment, aim the remote control directly at the remote control sensor on each equipment. Refer also to the instruction manuals supplied with your equipment.

## ■ Operating TV

- You can operate a JVC TV without setting the remote control signal setting.

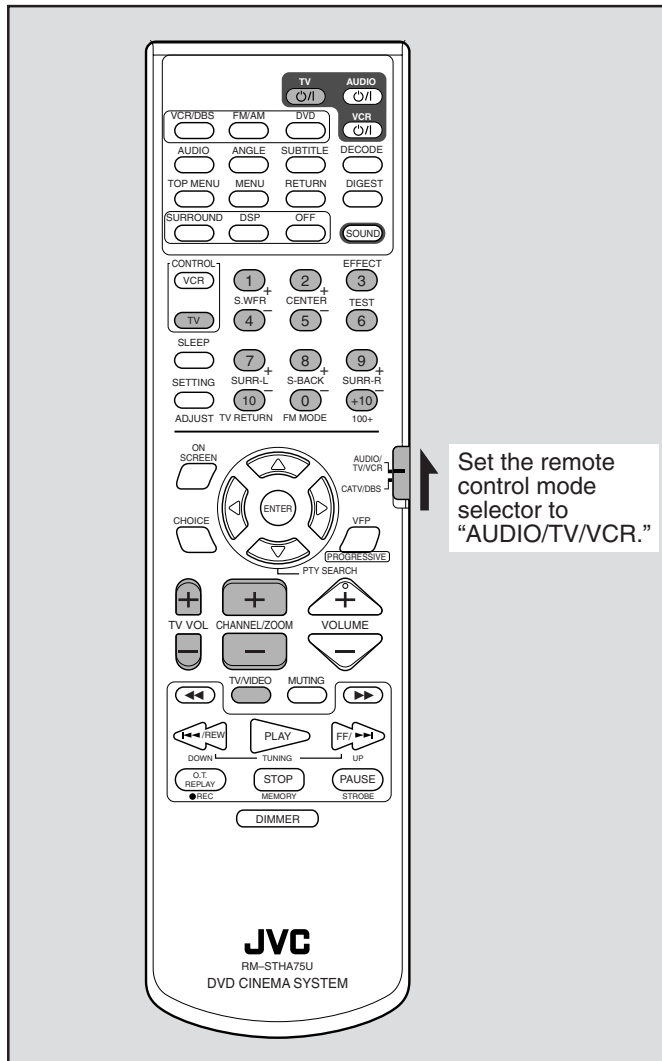

**1** Set the remote control mode selector to “AUDIO/TV/VCR.”

**2** Press and hold TV .  
• Keep it pressed up to step 5.

**3** Press TV CONTROL.

**4** Press the number buttons (1-9, 0) to enter a manufacturer's code (2 digit).

See the list below to find the codes.

Ex: For a Sanyo TV, press 1, then 3.

For a Toshiba TV, press 0, then 8.

**5** Release TV .

**6** Try to operate your TV by pressing TV .

When your TV turns on or off, you have entered the correct code.

If more than one code is listed for your brand of TV, try each one until you enter the correct one.

**After setting transmittable signals, you can use the following buttons for the TV operations.**

**TV :** Turns the TV on and off.

**TV VOL +/- :** Adjusts the volume.

**TV/VIDEO :** Selects the input mode (either TV or VIDEO).

After pressing **TV CONTROL**:

**CHANNEL +/- :** Changes the channels.

**1-10, 0, +10 (100+) :** Selects the channel.

**TV RETURN :** Alternates between the previously selected channel and the current channel.

## Manufacturers' codes for TV

Manufacturer	Code	Manufacturer	Code
JVC	01	Samsung	12
Hitachi	10	Sanyo	13
Magnavox	02	Sharp	06
Mitsubishi	03	Sony	07
Panasonic	04,11	Toshiba	08
RCA	05	Zenith	09

\* Manufacturers' codes are subject to change without notice. If they are changed, this remote control cannot operate the equipment.

## ■ Operating CATV converter or DBS tuner

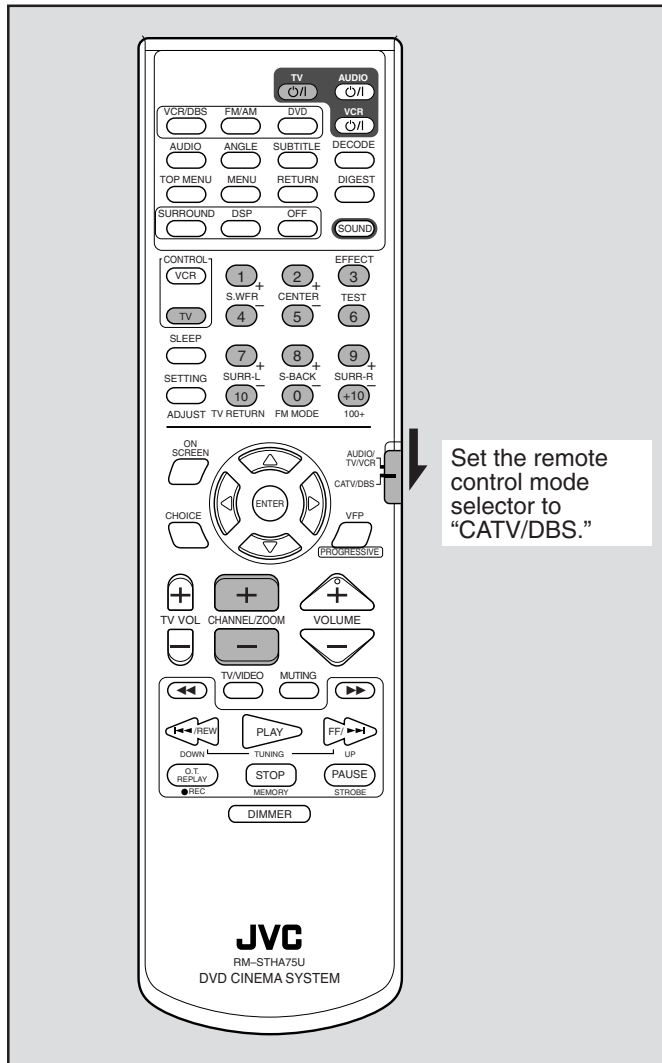

**1** Set the remote control mode selector to "CATV/DBS."

**2** Press and hold TV .

Keep it pressed up to step 5.

**3** Press TV CONTROL.

**4** Press the number buttons (1–9, 0) to enter a manufacturer's code (2 digit).

See the list below to find the code.

Ex.: For a Echostar product, press 2, then 1.

For a SONY product, press 2, then 0.

**5** Release TV .

**6** Try to operate your CATV converter or DBS tuner by pressing TV .

When your CATV converter or DBS tuner turns on or off, you have entered the correct code.

If more than one cord is listed for your brand of CATV converter or DBS tuner, try each one until you enter the correct one.

**After setting transmittable signals, you can use the following buttons for the CATV converter or DBS tuner operations.**

**TV**  : Turns on and off the CATV converter or DBS tuner.

**CHANNEL +/-** : Changes the channels.

**1-10, 0, +10 (100+)** : Selects the channel.

### Manufacturers' codes for CATV converter or DBS tuner

Manufacturer	Code
Echostar	21
GI Jerrold	01, 02, 03, 04, 05, 06, 07, 08
Hamlin/Regal	15, 16, 17, 18
Pioneer	13, 14
RCA	19
Scientific Atlanta	09, 10
Sony	20
Zenith	11, 12

\* Manufacturers' codes are subject to change without notice. If they are changed, this remote control cannot operate the equipment.

# Operating other manufacturers' video equipment

## ■ Operating VCR

- You can operate a JVC VCR without setting the remote control signal.

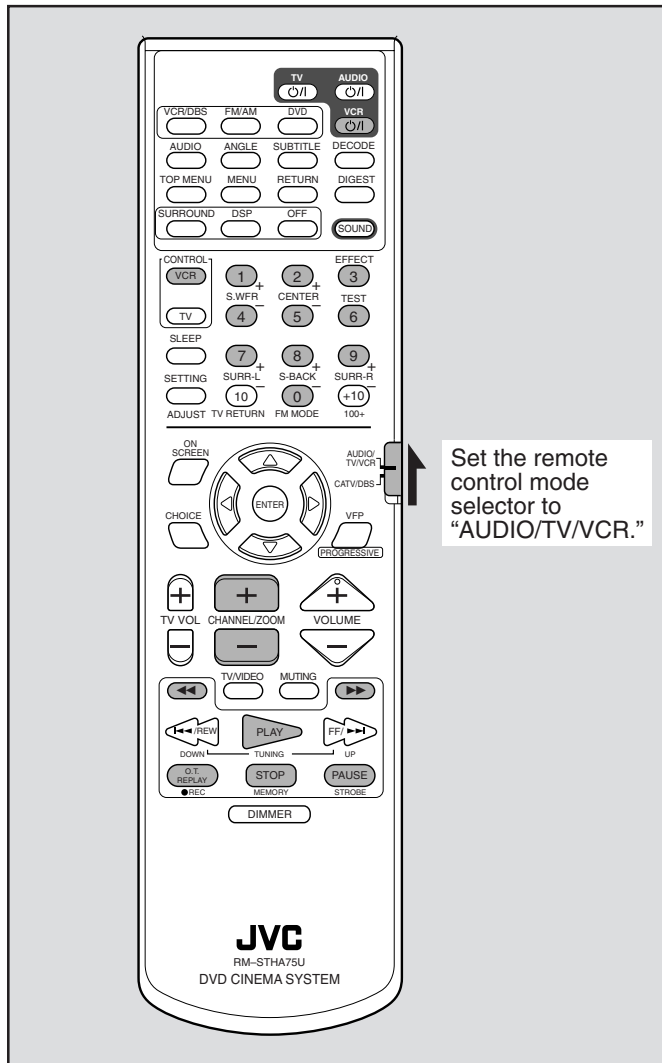

**1** Set the remote control mode selector to “AUDIO/TV/VCR.”

**2** Press and hold VCR .

Keep it pressed up to step 5.

**3** Press VCR CONTROL.

**4** Press the number buttons (1–9, 0) to enter a manufacturer’s code (2 digit).

See the list below to find the code.

Ex.: For a Philips VCR, press 0, then 9.

For a NEC VCR, press 2, then 5.

**5** Release VCR .

**6** Try to operate your VCR by pressing VCR .

When your VCR turns on or off, you have entered the correct code.

If more than one cord is listed for your brand of VCR, try each one until you enter the correct one.

**After setting transmittable signals, you can use the following buttons for the VCR operations.**

**VCR** : Turns the VCR on and off.

After pressing **VCR CONTROL**:

**PLAY** : Starts playback.

**STOP** : Stops operation.

**PAUSE** : Pauses playback.

: Fast forwards a video tape.

: Rewinds a video tape.

**REC** : Starts recording by pressing with PLAY.

Pauses recording by pressing with PAUSE.

**CHANNEL +/-** : Changes the TV channels on the VCR.

## Manufacturers' codes for VCR

Manufacturer	Code	Manufacturer	Code
JVC	01, 02, 03	Philips	09
Emerson	11, 26	RCA	05, 06
Fisher	29	Samsung	24
Funai	10, 14, 15, 16	Sanyo	21, 22, 23
Gold Star	12	Sharp	27, 28
Hitachi	04	Shintom	30
Mitsubishi	13	Sony	18, 19, 20
NEC	25	Zenith	08
Panasonic	07, 17		

\* Manufacturers' codes are subject to change without notice. If they are changed, this remote control cannot operate the equipment.



# Maintenance

To get the best performance of the system, keep your discs and mechanism clean.

## General Notes

In general, you will have the best performance by keeping your discs, and the mechanism clean.

- Store discs in their cases, and keep them in cabinets or on shelves.

## Handling Discs



- Remove the disc from its case by holding it at the edge while pressing the center hole lightly.
- Do not touch the shiny surface of the disc, or bend the disc.
- Put the disc back in its case after use to prevent warping.

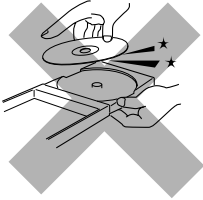

- Be careful not to scratch the surface of the disc when placing it back in its case.
- Avoid exposure to direct sunlight, temperature extremes, and moisture.



### To clean the disc

Wipe the disc with a soft cloth in a straight line from center to edge.

**DO NOT use any solvent—such as conventional record cleaner, spray, thinner, or benzine—to clean the disc.**

## Cleaning the system

### • Stains on the system

Should be wiped off with a soft cloth. If the unit is heavily stained, wipe it with a cloth soaked in water-diluted neutral detergent and wrung well, then wipe clean with a dry cloth.



### • Since the system may deteriorate in quality, become damaged or get its paint peeled off, be careful about the following.

- DO NOT wipe it with a hard cloth.
- DO NOT wipe it strong.
- DO NOT wipe it with thinner or benzine.
- DO NOT apply any volatile substance such as insecticides to it.
- DO NOT allow any rubber or plastic to remain in contact with it for a long time.

# Troubleshooting

Use this chart to help you solve daily operational problems. If there is any problem you cannot solve, contact your JVC service center.

- Refer also to the manuals supplied with the components you connect to this system.

	PROBLEM	POSSIBLE CAUSE	SOLUTION
General	<b>Power does not come on.</b>	The power cord is not plugged in.	Insert the plug into an AC outlet.
	<b>“OVERLOAD” flashes on the display.</b>	Speakers are overloaded because speaker cords are short.	Press $\odot/ $ on the center unit to turn off the system, check the speaker connection, then turn on the system again. If “OVERLOAD” reappears, unplug the power cord, then plug it back again. If speaker cords are not short, contact your dealer.
	<b>Suddenly, the system turns off.</b>	The sleep timer or Auto Standby is activated.	Turn these functions off. (See pages 18 and 56.)
		Speakers are overloaded because of high volume.	Press $\odot/ $ on the center unit to turn on the system again and adjust the volume.
		The protection circuit functions for some reason.	Check the speaker connection, then turn on the system again. If it does not solve the problem, contact your dealer.
	<b>No sound.</b>	Speaker cords are not connected.	Check speaker connection and reconnect if necessary.
		Speaker cords are short.	Check speaker connection.
		The audio cord is not connected correctly.	Connect the cord correctly.
		An incorrect source has been selected.	Select the correct source. (See page 16.)
		Muting is on.	Press MUTING to cancel muting.
	<b>Sound from one front speaker only.</b>	Incorrect analog/digital input mode is selected	Select the proper input mode. (See page 18.)
		Speaker cords connections are not correct.	Check connections.
	<b>No sound from the surround back speakers.</b>	The balance is set to one extreme.	Adjust the balance properly. (See pages 26 and 54.)
		The speaker setting is incorrect.	Set the speaker setting properly. (See pages 24 and 55.)
	<b>The remote control does not work.</b>	It is too far from the center unit, or is not facing the center unit.	Operate the remote control within 7 m from the remote sensor on the center unit.
		There is something obstructing the remote sensor.	Avoid any obstruction. (See page 15.)
		The remote control is not aimed at the remote sensor on the center unit or other components.	Aim the remote control at the remote sensor on each component you want to operate.
		The remote control mode selector is set at an incorrect position.	Set it to the correct position, “AUDIO/TV/VCR” or “CATV/DBS.”
The batteries are exhausted.		Replace the batteries.	
The batteries have been inserted the wrong way round (+/-).		Insert the batteries correctly.	
Incorrect button is selected before operation you are going to do.		Select a correct source by pressing DVD, FM/AM or VCR/TV CONTROL. Press SOUND before you perform sound adjustment.	
Sunlight is falling directly on the remote sensor.		Shade the remote sensor from direct sunlight.	
The remote control signals are not set correctly.		Enter the correct manufacturer's code. (See pages 62 to 64.)	
<b>6.1-channel reproduction cannot be done from Dolby Digital EX or DTS-ES software.</b>		Reproduced non 6.1-channel software or “EX/ES” is set to “OFF.”	Playback software bearing the mark  or  Set “EX/ES” to “ON” or “AUTO.”
<b>Bass sound is heard reinforced when listening in stereo.</b>	Appropriate bass level for stereo sound is not selected.	Adjust “AUDIO POS.” (See page 26).	

PROBLEM	POSSIBLE CAUSE	SOLUTION
<b>No picture is displayed on the TV screen.</b>	The video cord is not connected correctly.	Connect the cord correctly. (See page 7.)
	Incorrect TV input mode is selected.	Select the correct input mode on the TV.
<b>No picture is displayed on the TV screen, the picture is blurred, or the picture is divided into two parts.</b>	The scanning mode is set to "PROGRESSIVE" though the system is connected to the TV which does not support the progressive video input such as a conventional TV.	Change the scanning mode to "INTERLACE." (See page 19.)
<b>A disc cannot be played.</b>	The disc is not playable.	Use a playable disc. (See page 5.)
	The disc Region Code numbers are incompatible.	Replace the disc. (See page 5.)
	Playback is restricted by Parental Lock.	Enter password to change the Parental Lock level. (See page 58.)
<b>A disc cannot be played and "0:00" is displayed on the display window.</b>	The disc is loaded with its label and data sides inverted.	Load the disc correctly. (See page 20.)
<b>Video and audio are distorted.</b>	An unplayable disc is inserted.	Replace the disc. (See page 5.)
	The disc is scratched or dirty.	Replace or clean the disc. (See page 65.)
<b>The picture does not fit the TV screen.</b>	A VCR is connected between the center unit and the TV.	Connect the center unit and TV directly.
	"PROGRESSIVE MODE" may not be set appropriately for the current disc.	Change the setting for "PROGRESSIVE MODE." (See page 53.)
	"MONITOR TYPE" is not set correctly.	Set the monitor type correctly. (See page 53.)
<b>One touch DVD play does not work though you have connected AV COMPU LINK cord correctly.</b>	The TV is not set correctly.	Set the TV correctly.
	The video output jack type to watch the DVD playback is not set correctly.	Select the correct video output jack type to watch the DVD playback. (See page 25.)
<b>No subtitle appears on the TV screen though you have selected as your initial subtitle language.</b>	_____	Some DVDs are programmed to always display no subtitle initially. If this happens, press SUBTITLE on the remote control after starting play. (See page 37.)
<b>Audio language is different from the one you have selected as your initial audio language.</b>	_____	Some DVDs are programmed to always use the original language initially. If this happens, press AUDIO on the remote control after starting play. (See page 37.)
<b>Hard to listen to broadcast because of noise.</b>	Antennas are disconnected.	Reconnect the antennas correctly and securely.
	—For AM The AM loop antenna is too close to the center unit.	Change the position and direction of the AM loop antenna.
—For FM	Beat Cut mode is not set properly.	Try to change the Beat Cut mode. (See page 23.)
	The supplied FM antenna is not properly extended and positioned.	Extend the FM antenna at the best position.
<b>Continuous static during FM broadcasts.</b>	The received signal is too weak.	Connect an external FM antenna (see page 9), or contact your dealer.
	The station is too far away.	Select another station.
	An incorrect antenna is used.	Check with your dealer to be sure you have a correct antenna.

# Troubleshooting

	PROBLEM	POSSIBLE CAUSE	SOLUTION
MP3 Playback	<b>A disc cannot be played.</b>	No MP3 files are recorded on the disc.	Replace the disc.
		MP3 files do not have the correct file extension in their file names.	Add the file extension—.mp3, .Mp3, .mP3, or .MP3—as their file names. (See page 46.)
		MP3 files are not recorded in the format compliant with ISO 9660 Level 1 or 2.	Replace the disc. (Record MP3 files using a compliant application.)
	MP3 files are made at the bit rate of less than 64 kbps.	This system cannot playback such discs. Replace the disc.	
<b>Not MP3 files but JPEG files are played.</b>	The MP3/JPEG setting is set to “JPEG.”	When both MP3 files and JPEG files are recorded on a disc, to play MP3 files, set the setting to “MP3.” (See page 53.)	
<b>The MP3 control screen appears on the TV screen, but any operation cannot be performed.</b>	Any MP3 files or JPEG files are not recorded on the disc, or the disc is the unplayable disc (such as CD-ROM).	Replace the disc. (See page 5.)	
JPEG Playback	<b>A disc cannot be played.</b>	No JPEG files are recorded on the disc.	Replace the disc.
		JPEG files do not have the correct file extension in their file names.	Add the file extension—.jpg, .jpeg, .JPG, .JPEG or any uppercase and lowercase combination (such as “.Jpg”)—as their file names. (See page 48.)
		JPEG files are not recorded in the format compliant with ISO 9660 Level 1 or 2.	Replace the disc. (Record JPEG files using a compliant application.)
	<b>Not JPEG files but MP3 files are played.</b>	The MP3/JPEG setting is set to “MP3.”	When both MP3 files and JPEG files are recorded on a disc, set the setting to “JPEG.” (See page 53).

# Glossary

## Aspect ratio

The ratio of vertical and horizontal sizes of a displayed image. The horizontal vs. vertical ratio of conventional TVs is 4:3, and that of wide-screen TVs is 16:9.

## Chapter

See "Titles and chapters."

## Component video signal

A video signal system where parts of information necessary for reproducing image signal comprised of the three primary colors of light are transmitted via separate signal lines. Types of signal, such as R/G/B, Y/P<sub>B</sub>/P<sub>R</sub>, etc., are available.

## Composite video signal

Refers to video signal comprised of three kinds of signals combined: an image signal made up of luminance and chrominance signals using the frequency multiplication technique; burst signal providing the basis for color reproduction; and synchronization signal.

## Disc menu

A screen display prepared for allowing selection of images, sounds, subtitles, multiangles, etc. recorded on a DVD.

## Interlaced scanning

In the conventional video system, a picture is shown on the display monitor in two halves. The Interlaced scanning system places lines of the second half of the picture in-between lines of the first half of the picture.

## JPEG

A still-picture data compression system proposed by the Joint Photographic Expert Group, which features little deterioration in image quality in spite of its high compression ratio.

## Letter box

A method of displaying wide images like movies on a 4:3 TV screen with no part of the image deleted, by placing black bands on the top and bottom of the screen. This name has derived from the screen form looking literally like a letter box.

## Linear PCM (PCM: Pulse Code Modulation)

A system for converting analog sound signal to digital signal for later processing, with no data compression used in conversion.

## MP3

A file format with a sound data compression system. "MP3" is the abbreviation of Motion Picture Experts Group 1 (or MPEG-1) Audio Layer 3. By using MP3 format, one CD-R or CD-RW can contain about 10 times as much data volume as a regular CD can.

## Multi-angle

By recording multiple scenes progressing at the same time in a single title, the user can select view angles. This feature is called the multi angle function.

## Multi-channel

Software having 3 or more channels. Most DVD have more than 5 audio channels. Reproducing such software using multiple speakers creates a realistic sound field like a theater.

## Multi-language

DVD can have multiple subtitle (up to 32) and audio (up to 8) languages.

## Parental lock

A feature of this system to automatically determine whether or not to reproduce particular DVD software by comparing its parental level (a measure of undesirability of scenes, etc. from educational viewpoint) set for the software beforehand with that set on this system by the user; if the software's level is less restrictive than the user-set level, it will be reproduced.

## Playback control (PBC)

Refers to the signal recorded on video CDs or SVCDs for controlling reproduction. By using menu screens recorded on a Video CD or SVCD that supports PBC, you can enjoy interactive-type software as well as software having a search function.

## Progressive scanning

Progressive scanning displays all the horizontal lines of a picture at one time, as a single frame. This system can convert the interlaced video from DVD into progressive format for connection to a progressive display. It dramatically increases the vertical resolution.

## Region code

A system for allowing discs to be played back only in the regions designated beforehand. All the countries in the world are divided into six regions, each region being identified by a specified region code (or region number). If the region code given to a disc includes a numeral which matches one in the region code of a player, the player can play back the disc.

## Sampling frequency

Frequency of sampling data when analog data is converted to digital data. Sampling frequency numerically represents how many times the original analog signal is sampled per second.

## Surround

A system for creating three-dimensional sound fields full of realism by arranging multiple speakers around the listener.

## S-video signal

Video signal separated into a Y (luminance) signal and a C (chrominance) signal. This separation of the video results higher resolution and better quality.

## Titles and chapters

A DVD is divided into several titles (large divisions), and each title is divided into chapters (small divisions). These divisions are assigned their particular numbers, so that they are easily accessed.

## Transfer rate

The rate of transferring digital data. Usually the measure is in baud per second. The DVD system applies a variable transfer rate system for high efficiency.

# Specifications

Designs & specifications are subject to change without notice.

## ■ Center unit (XV-THA75)

### Output Power

FRONT/CENTER/SURROUND/SURROUND BACK:

20 W × 6, 4 Ω, 1 kHz, 0.7% THD

30 W × 6, 4 Ω, 1 kHz, 10% THD

SUBWOOFER:

100 W, 4 Ω, 100 Hz, 0.7% THD

140 W, 4 Ω, 100 Hz, 10% THD

### Audio section

Audio input sensitivity/Impedance (at 1 kHz)

Analog input:

DBS/VCR: 340 mV/47 kΩ

Digital input\*:

DIGITAL IN (DBS): -21 dBm to -15 dBm  
(660 nm ±30 nm)

\* Corresponding to Linear PCM, Dolby Digital, and DTS Digital Surround (with sampling frequency — 32 kHz, 44.1 kHz, 48 kHz)

### Video section

Color System: NTSC/PAL compatible

Horizontal Resolution: 500 lines

Signal-to-Noise Ratio: 70 dB

VIDEO output sensitivity/Impedance (at 1 kHz)

Composite: 1.0 V(p-p)/75 Ω

S-video-Y: 1.0 V(p-p)/75 Ω

S-video-C: 0.286 V(p-p)/75 Ω

Component-Y: 1.0 V(p-p)/75 Ω

Component-P<sub>B</sub>, P<sub>R</sub>: 0.7 V(p-p)/75 Ω

VIDEO input sensitivity/Impedance (at 1 kHz)

Composite:

VCR IN, DBS IN: 1.0 V(p-p)/75 Ω

S-video-Y:

VCR IN, DBS IN: 1.0 V(p-p)/75 Ω

S-video-C:

VCR IN, DBS IN: 0.286 V(p-p)/75 Ω

### Tuner section

Tuning Range

FM: 87.50 MHz – 108.00 MHz

AM : 531 kHz – 1 602 kHz  
(at 9 kHz intervals)  
530 kHz – 1 600 kHz  
(at 10 kHz intervals)

### General

Power Requirements: AC 240 V ~, 50 Hz

Power Consumption: 165 W (at operation)  
2.5 W (in standby mode)

Dimensions: 435 mm × 70 mm × 353 mm  
(W × H × D)

Mass (approx.): 5.0 kg

## ■ Subwoofer (SP-WA75)

Speaker:	20 cm Bass-reflex, Magnetically Shielded
Power Handling Capacity:	120 W
Impedance:	4 Ω
Frequency Range:	25 Hz to 200 Hz
Dimensions:	200 mm × 410 mm × 428 mm (W × H × D)
Mass (approx.):	9.1 kg

## ■ Satellite Speakers (SP-XSA75)

Speakers:	7 cm × 4 cm Bass-reflex, Magnetically Shielded
Power Handling Capacity:	30 W
Impedance:	4 Ω
Frequency Range:	110 Hz to 20 kHz
Dimensions:	62 mm × 102 mm × 109 mm (W × H × D)
Mass (approx.):	440 g

## ■ Center Speaker (SP-XCA75)

Speaker:	7 cm × 4 cm Bass-reflex, Magnetically Shielded
Power Handling Capacity:	30 W
Impedance:	4 Ω
Frequency Range:	100 Hz to 20 kHz
Dimensions:	152 mm × 62 mm × 109 mm (W × H × D)
Mass (approx.):	475 g

## ■ Accessories

- Remote control (1)
- Batteries (2)
- FM antenna (1)
- AM loop antenna (1)
- Composite video cord (1)
- AV COMPU LINK cord (1)
- Core filter (1)
- Speaker cords
  - Approx. 5 m (3) with a mini plug:
    - For the left front speaker, right front speaker, and center speaker
  - Approx. 5 m (1): For subwoofer
  - Approx. 10 m (3) with a mini plug:
    - For the left surround speaker, right surround speaker, and surround back speaker
- Satellite speaker wall brackets (5)
- Screws for the satellite speaker wall brackets (5)







VICTOR COMPANY OF JAPAN, LIMITED